



**ES-60W**

# **User's Guide**

# Copyright

No part of this publication may be reproduced, stored in a retrieval system, or transmitted in any form or by any means, electronic, mechanical, photocopying, recording, or otherwise, without the prior written permission of Seiko Epson Corporation. No patent liability is assumed with respect to the use of the information contained herein. Neither is any liability assumed for damages resulting from the use of the information herein. The information contained herein is designed only for use with this Epson product. Epson is not responsible for any use of this information as applied to other products.

Neither Seiko Epson Corporation nor its affiliates shall be liable to the purchaser of this product or third parties for damages, losses, costs, or expenses incurred by the purchaser or third parties as a result of accident, misuse, or abuse of this product or unauthorized modifications, repairs, or alterations to this product, or (excluding the U.S.) failure to strictly comply with Seiko Epson Corporation's operating and maintenance instructions.

Seiko Epson Corporation and its affiliates shall not be liable for any damages or problems arising from the use of any options or any consumable products other than those designated as Original Epson Products or Epson Approved Products by Seiko Epson Corporation.

Seiko Epson Corporation shall not be held liable for any damage resulting from electromagnetic interference that occurs from the use of any interface cables other than those designated as Epson Approved Products by Seiko Epson Corporation.

© 2018 Seiko Epson Corporation

The contents of this manual and the specifications of this product are subject to change without notice.

## Trademarks

# Trademarks

- ❑ EPSON® is a registered trademark, and EPSON EXCEED YOUR VISION or EXCEED YOUR VISION is a trademark of the Seiko Epson Corporation.
- ❑ Microsoft, Windows, and Windows Vista are either registered trademarks or trademarks of Microsoft Corporation in the United States and/or other countries.
- ❑ Apple, macOS, and OS X are trademarks of Apple Inc., registered in the U.S. and other countries.
- ❑ Adobe, Adobe Reader, and Acrobat are registered trademarks of Adobe Systems Incorporated.
- ❑ Intel® is a registered trademark of Intel Corporation.
- ❑ Wi-Fi, Wi-Fi Alliance, and Wi-Fi Protected Access (WPA) are registered trademarks of the Wi-Fi Alliance. Wi-Fi Protected Setup, and WPA2 are trademarks of the Wi-Fi Alliance.
- ❑ General Notice: Other product names used herein are for identification purposes only and may be trademarks of their respective owners. Epson disclaims any and all rights in those marks.

## Contents

### Copyright

### Trademarks

### About This Manual

Introduction to the Manuals. . . . .	6
Marks and Symbols. . . . .	6
Descriptions Used in this Manual. . . . .	6
Operating System References. . . . .	7

### Important Instructions

Safety Instructions. . . . .	8
Safety Instructions for the Battery. . . . .	9
Disposing of European Scanner Models. . . . .	9
Restrictions on Copying. . . . .	10

### Scanner Basics

Part Names and Functions. . . . .	11
Buttons and Lights on the Control Panel. . . . .	11
Buttons and Lights. . . . .	11
Error Indicators. . . . .	13
Information on Applications. . . . .	14
Epson ScanSmart. . . . .	14
EPSON Software Updater. . . . .	14
Epson DocumentScan. . . . .	14
EpsonNet Config. . . . .	14
Option Items and Consumables Information. . . . .	15
Carrier Sheet Codes. . . . .	15
Maintenance Sheet Codes. . . . .	15

### Using the Scanner on the Battery

Checking the Battery Level. . . . .	16
Charging the Battery. . . . .	16
Battery Charging Precautions. . . . .	16
Charging the Battery. . . . .	16

### Network Settings

Network Connection Types. . . . .	18
Wi-Fi Connection. . . . .	18
Wi-Fi Direct (Simple AP) Connection. . . . .	18
Connecting to a Computer. . . . .	19
Connecting to a Smart Device. . . . .	20

Making Wi-Fi Settings from the Control Panel. . . . .	20
Making Wi-Fi Settings Using Push Button Setup (WPS). . . . .	20
Making Wi-Fi Settings by PIN Code Setup (WPS). . . . .	21
Making Wi-Fi Direct (Simple AP) Connection Settings. . . . .	22
Checking the Network Status Using Network Light. . . . .	23
Replacing or Adding New Wireless Routers. . . . .	23
Changing the Connection Method to a Computer. . . . .	23
Disabling the Wi-Fi. . . . .	24
Restoring the Network Settings from the Control Panel. . . . .	24

### Specifications of Originals and Placing Originals

Specifications of Originals. . . . .	26
General Specifications for Originals being Scanned. . . . .	26
Types of Originals that Require Attention. . . . .	28
Types of Originals that Must Not be Scanned. . . . .	28
Placing the Original. . . . .	29
Placing Standard Size Originals. . . . .	29
Placing Long Paper. . . . .	30
Placing Receipts. . . . .	31
Placing Envelopes. . . . .	32
Placing Plastic Cards. . . . .	33
Placing Irregular Shaped Originals. . . . .	35

### Basic Scanning

Scanning Using a Scanner Button. . . . .	37
Scanning and Saving Documents. . . . .	37
Scanning Using Epson DocumentScan. . . . .	41

### Advanced Scanning

Scanning Different Sizes or Types of Originals One by One Continuously (Automatic Feeding Mode). . . . .	46
Saving as Editable Files (Microsoft® Office). . . . .	48
Sending to a Cloud Service. . . . .	50

### Maintenance

Cleaning Outside the Scanner. . . . .	55
---------------------------------------	----

## Contents

Cleaning Inside the Scanner. . . . .	55
Scanner Adjustment Using the Calibration Sheet. . .	56
Energy Saving. . . . .	57
Carrying the scanner. . . . .	58
Updating Applications and Firmware. . . . .	59

### **Solving Problems**

Scanner Problems. . . . .	60
Scanner Lights Indicate an Error. . . . .	60
The Scanner Does Not Turn On. . . . .	60
The Scanner Turns Off when Running on the Battery. . . . .	60
The Scanner Does not Turn Off when Running on the Battery. . . . .	61
Problems Starting Scanning. . . . .	61
Cannot Start Epson ScanSmart. . . . .	61
Removing Jammed Originals from the Scanner. . .	63
The Originals Get Dirty. . . . .	63
Scanning Takes a Long Time. . . . .	63
Scanned Image Problems. . . . .	64
Streaks Appear in the Scanned Image. . . . .	64
Offset Appears in the Background of Images. . .	64
Scanned Image or Text is Blurred. . . . .	64
Moiré Patterns (Web-Like Shadows) Appear. . .	65
The Edge of the Original is Not Scanned when Automatically Detecting the Size of the Original. . . . .	66
Character is not Recognized Correctly. . . . .	66
Expanding or Contracting the Scanned Image. . .	67
The Scanned Image of the Plastic Card is Enlarged. . . . .	67
Cannot Solve Problems in the Scanned Image. . .	67
Network Problems. . . . .	68
When You Cannot Make Network Settings. . . . .	68
The Scanner Suddenly Cannot Scan over a Network Connection. . . . .	72
The Scanner Suddenly Cannot Scan Using a USB Connection. . . . .	72
Uninstalling and Installing Applications. . . . .	72
Uninstalling Your Applications. . . . .	72
Installing Your Applications. . . . .	74

### **Technical Specifications**

General Scanner Specifications. . . . .	75
Wi-Fi Specifications. . . . .	76
Dimensional Specifications. . . . .	76
Electrical Specifications. . . . .	76

Scanner Electrical Specifications. . . . .	76
Battery Specifications. . . . .	77
Environmental Specifications. . . . .	77
System Requirements. . . . .	78

### **Standards and Approvals**

Standards and Approvals for U.S. Model. . . . .	79
Standards and Approvals for European Model. . . . .	79
Standards and Approvals for Australian Models. . . . .	80

### **Where to Get Help**

Technical Support Web Site. . . . .	81
Contacting Epson Support. . . . .	81
Before Contacting Epson. . . . .	81
Help for Users in Europe. . . . .	81
Help for Users in Taiwan. . . . .	82
Help for Users in Australia. . . . .	82
Help for Users in Singapore. . . . .	83
Help for Users in Thailand. . . . .	83
Help for Users in Vietnam. . . . .	83
Help for Users in Indonesia. . . . .	84
Help for Users in Hong Kong. . . . .	85
Help for Users in Malaysia. . . . .	86
Help for Users in India. . . . .	86
Help for Users in the Philippines. . . . .	87

# About This Manual

---

## Introduction to the Manuals

The latest versions of the following manuals are available from the Epson support website.

<http://www.epson.eu/Support> (Europe)

<http://support.epson.net/> (outside Europe)

Setup Guide (paper manual)

Provides you with information on setting up the product and installing the application.

User's Guide (digital manual)

Provides instructions on using the product, maintenance, and solving problems.

As well as the manuals above, see the help included in the various Epson applications.

---

## Marks and Symbols



**Caution:**

*Instructions that must be followed carefully to avoid bodily injury.*



**Important:**

*Instructions that must be observed to avoid damage to your equipment.*

**Note:**

*Provides complementary and reference information.*

### Related Information

➔ Links to related sections.

---

## Descriptions Used in this Manual

- Screenshots for the applications are from Windows 10 or Mac OS X v10.13.x. The content displayed on the screens varies depending on the model and situation.
- Illustrations used in this manual are for reference only. Although they may differ slightly from the actual product, the operating methods are the same.

---

## Operating System References

### Windows

In this manual, terms such as "Windows 10", "Windows 8.1", "Windows 8", "Windows 7", "Windows Vista", and "Windows XP" refer to the following operating systems. Additionally, "Windows" is used to refer to all versions.

- Microsoft® Windows® 10 operating system
- Microsoft® Windows® 8.1 operating system
- Microsoft® Windows® 8 operating system
- Microsoft® Windows® 7 operating system
- Microsoft® Windows Vista® operating system
- Microsoft® Windows® XP operating system Service Pack 3
- Microsoft® Windows® XP Professional x64 Edition operating system Service Pack 2

### Mac OS

In this manual, "Mac OS" is used to refer to macOS High Sierra, macOS Sierra, OS X El Capitan, OS X Yosemite, OS X Mavericks, OS X Mountain Lion, Mac OS X v10.7.x, and Mac OS X v10.6.8.

# Important Instructions

---

## Safety Instructions

Read and follow these instructions to ensure safe use of this product. Make sure you keep this manual for future reference. Also, be sure to follow all warnings and instructions marked on the product.

- ❑ Some of the symbols used on your product are to ensure safety and proper use of the product. Visit the following Web site to learn the meaning of the symbols.  
<http://support.epson.net/symbols>
- ❑ Place the product on a flat, stable surface that extends beyond the base of the product in all directions. If you place the product by the wall, leave more than 10 cm between the back of the product and the wall.
- ❑ Place the product close enough to the computer for the interface cable to reach it easily. Do not place or store the product outdoors, near excessive dirt or dust, water, heat sources, or in locations subject to shocks, vibrations, high temperature or humidity, direct sunlight, strong light sources, or rapid changes in temperature or humidity.
- ❑ Do not use with wet hands.
- ❑ The USB cable should be placed to avoid abrasions, cuts, fraying, crimping, and kinking. Do not place objects on top of the cord and do not allow the cord to be stepped on or run over. Be particularly careful to keep the cord straight at the end.
- ❑ Use only the USB cable supplied with your product. Using any other USB cable could cause fire, electrical shock, or injury.
- ❑ The USB cable is designed for use with the product with which it was included. Do not attempt to use it with other electronic devices unless specified.
- ❑ When connecting this product to a computer or other device with a cable, ensure the correct orientation of the connectors. Each connector has only one correct orientation. Inserting a connector in the wrong orientation may damage both devices connected by the cable.
- ❑ Never disassemble, modify, or attempt to repair the product, or product option by yourself except as specifically explained in the product's guides.
- ❑ Do not insert objects into any opening as they may touch dangerous voltage points or short out parts. Beware of electrical shock hazards.
- ❑ Unplug the product and the USB cable, and refer servicing to qualified service personnel under the following conditions: liquid has entered the product; the product has been dropped or the case has been damaged; the product does not operate normally or exhibits a distinct change in performance. (Do not adjust controls that are not covered by the operating instructions.)
- ❑ If you are not going to use the product for a long period, be sure to unplug the USB cable from the computer.
- ❑ Keep this product at least 22 cm away from cardiac pacemakers. Radio waves from this product may adversely affect the operation of cardiac pacemakers.
- ❑ Do not use this product inside medical facilities or near medical equipment. Radio waves from this product may adversely affect the operation of electrical medical equipment.
- ❑ Do not use this product near automatically controlled devices such as automatic doors or fire alarms. Radio waves from this product may adversely affect these devices, and could lead to accidents due to malfunction.

## Important Instructions

### Safety Instructions for the Battery

- ❑ If the battery is not fully charged within the specified time, stop charging. Otherwise, the battery could become hot, emit smoke, rupture, or catch fire.
- ❑ Do not place the product in a microwave oven or a high-pressure container. Otherwise, the battery could become hot, emit smoke, rupture, or catch fire.
- ❑ If liquid leaks from the product, or the product emits a bad odour, move the product away from flammable objects immediately. If it is not moved, electrolytes leaking from the battery become hot, emit smoke, rupture, or catch fire.
- ❑ If battery acid gets in your eyes, immediately rinse your eyes thoroughly with fresh water without rubbing them, and then see a doctor immediately. Otherwise, permanent eye damage could result.
- ❑ If battery acid gets on your skin, immediately rinse the affected area thoroughly with water, and then see a doctor immediately.
- ❑ Do not drop or throw the product or subject it to strong shocks. Otherwise, the battery could leak or the protection circuit in the battery could be damaged. As a result, the battery could become hot, emit smoke, rupture, or catch fire.
- ❑ Do not use or leave the product in a hot location (more than 60°C), such as near a fire or a heater. Otherwise, the plastic separator could melt and the individual cells could short-circuit. As a result, the battery could become hot, emit smoke, rupture, or catch fire.
- ❑ Do not use the product if it is leaking or damaged in any way. Otherwise, the battery could become hot, emit smoke, rupture, or catch fire.
- ❑ Do not leave the product in a vehicle. Otherwise, the battery could overheat.

---

## Disposing of European Scanner Models

There is a battery in the scanner.

The crossed out wheeled bin label that can be found on your product indicates that this product and incorporated batteries should not be disposed of in the normal household waste stream. To prevent possible harm to the environment or human health please separate this product and its batteries from other waste streams to ensure that it can be recycled in an environmentally sound manner. For more details on available collection facilities please contact your local government office or the retailer where you purchased this product. Use of the chemical symbols Pb, Cd or Hg indicates if these metals are used in the battery.

This information only applies to customers in the European Union, according to Directive 2006/66/EC OF THE EUROPEAN PARLIAMENT AND OF THE COUNCIL OF 6 September 2006 on batteries and accumulators and waste batteries and accumulators and repealing Directive 91/157/EEC and legislation transposing and implementing it into the various national legal systems, and to customers in countries in Europe, Middle East and Africa (EMEA) where they have implemented equivalent regulations.

For other countries, please contact your local government to investigate the possibility of recycling your product.



## Important Instructions

---

# Restrictions on Copying

Observe the following restrictions to ensure the responsible and legal use of your product.

Copying of the following items is prohibited by law:

- Bank bills, coins, government-issued marketable securities, government bond securities, and municipal securities
- Unused postage stamps, pre-stamped postcards, and other official postal items bearing valid postage
- Government-issued revenue stamps, and securities issued according to legal procedure

Exercise caution when copying the following items:

- Private marketable securities (stock certificates, negotiable notes, checks, etc.), monthly passes, concession tickets, etc.
- Passports, driver's licenses, warrants of fitness, road passes, food stamps, tickets, etc.

**Note:**

*Copying these items may also be prohibited by law.*

Responsible use of copyrighted materials:

Products can be misused by improperly copying copyrighted materials. Unless acting on the advice of a knowledgeable attorney, be responsible and respectful by obtaining the permission of the copyright holder before copying published material.

# Scanner Basics

## Part Names and Functions

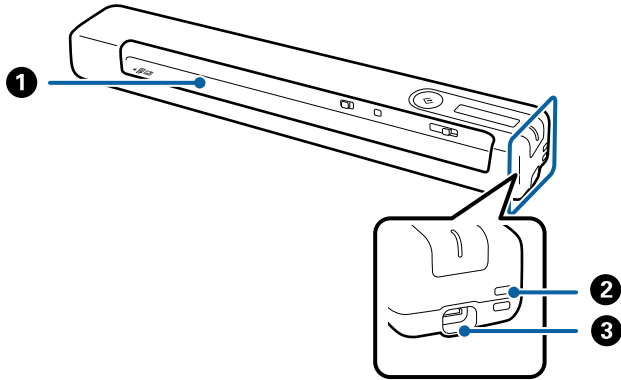







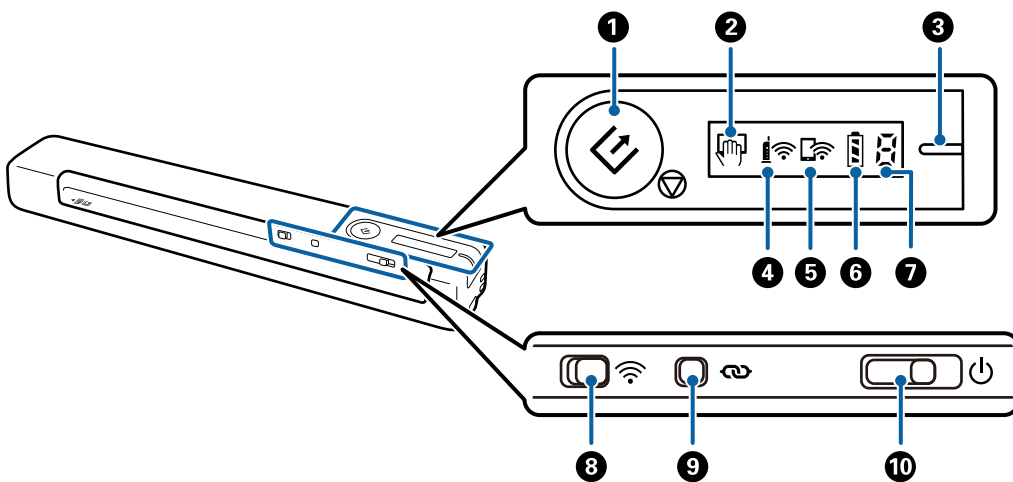





1	Input slot	Input the original.
2	Loophole	Connect straps.
3	USB port	USB bus power. Connects a USB cable. To avoid causing any damage, do not add excessive force when connecting the USB cable to the USB port.

## Buttons and Lights on the Control Panel

### Buttons and Lights



**Scanner Basics**

<p>1</p>  	<p>Start and stop button</p>	<ul style="list-style-type: none"> <li><input type="checkbox"/> Starts or cancels scanning.</li> <li><input type="checkbox"/> Press this when cleaning the inside of the scanner.</li> <li><input type="checkbox"/> Exits Automatic Feeding Mode.</li> </ul>
<p>2</p> 	<p>Automatic Feeding Mode light</p>	<p>The scanner is in Automatic Feeding Mode. Scanning starts when an original is placed in the input tray.</p>
<p>3</p> <p>-</p>	<p>Ready light</p>	<p>On (white)</p> <p>The scanner is ready to be used.</p> <p>When the power is off and you connect a USB cable to the scanner, the ready light turns on, but you cannot use the scanner until  light is displayed.</p>
		<p>Flashing (white)</p> <p>The scanner is scanning, waiting to scan, processing, or sleeping.</p>
		<p>Off</p> <p>The scanner cannot be used because the power is off.</p>
		<p>On (Orange)</p> <p>An error has occurred. See "Error Indicators" for more details.</p>
<p>4</p> 	<p>Wi-Fi light</p>	<p>Indicates that the scanner is connected to a wireless (Wi-Fi) network through an access point.</p>
<p>5</p> 	<p>Wi-Fi AP mode light</p>	<p>Indicates that the scanner is connected to a wireless (Wi-Fi) in simple AP mode without an access point.</p>
<p>6</p> 	<p>Battery light</p>	<p>On</p> <p>Indicates the battery level of the scanner. When the battery is running low, connect it to the computer using the USB cable to start charging.</p>
		<p>Flashing</p> <p>The battery is charging. When charging is complete, the battery level indicates that it is full.</p>
<p>7</p> 	<p>Error status light</p>	<p>An error has occurred. See "Error Indicators" for more details.</p>
<p>8</p> 	<p>Wi-Fi switch</p>	<p>When connecting to a wireless (Wi-Fi) network, slide the switch to the icon on the right hand side to turn it on.</p>
<p>9</p> 	<p>Wi-Fi connect button</p>	<p>Hold down the  button for more than three seconds to connect to a Wi-Fi network. See the chapter "Network Settings" for more details.</p>
<p>10</p> 	<p>Power switch</p>	<p>Slide the switch to turn the scanner on or off.</p> <p>Slide the switch to the right and hold it there until the ready light starts flashing.</p> <p>It takes about 10 seconds to turn off after sliding the switch.</p>

**Note:**

When turning on the scanner for the first time, connect it to the computer with the USB cable, and then slide the power switch to on.





**Related Information**

- ➔ ["Network Settings" on page 18](#)
- ➔ ["Using the Scanner on the Battery" on page 16](#)
- ➔ ["Error Indicators" on page 13](#)



Scanner Basics

Error Indicators



Scanner errors

Indicators	Situation	Solutions
	A paper jam has occurred.	Remove jammed original, and then load the original again.
	A fatal error has occurred.	Turn the power off and on again. If the error continues to occur, contact your local dealer.
	The firmware update failed.	Follow the steps below to try to update the firmware again.
	The scanner has started in recovery mode.	<ol style="list-style-type: none"> <li>1. Connect the computer and the scanner with a USB cable. (During recovery mode, you cannot update the firmware over a network connection.)</li> <li>2. Visit your local Epson website for further instructions.</li> </ol>





Battery charging errors

Indicators	Situation	Solutions
	Battery charging has been stopped because it became too hot.	Charge the battery in an ambient temperature of 8°C to 35°C (46 to 95 °F).
	Battery charging has stopped because it is too cold.	
	The battery cannot be fully charged even if you are charging the battery within the guaranteed charging temperature range (8 to 35 °C (46 to 95 °F)). It may be damaged or has reached the end of its service life.	Contact your local dealer.

Network connection errors

Indicators	Situation	Solutions
	An access point settings error has occurred.  and  light flash at the same time.	Restart the scanner and access point, move them closer together, and then make network settings again.

## Scanner Basics

Indicators	Situation	Solutions
	<p>Epson ScanSmart does not start when you press the  button when using the scanner over a network.</p> <p>The  and  lights flash at the same time.</p>	<p>See "Cannot Start Epson ScanSmart" in "Solving Problems" for more details.</p>

### Related Information

- ➔ [“Making Wi-Fi Settings from the Control Panel” on page 20](#)
- ➔ [“Network Problems” on page 68](#)
- ➔ [“Cannot Start Epson ScanSmart” on page 61](#)

---

## Information on Applications

This section introduces the application products available for your scanner. The latest application can be installed at the Epson Web site.

### Epson ScanSmart

Epson ScanSmart is a document scanning application that allows you to easily scan and save the data in simple steps.

- You can scan and send information to a cloud service in three easy steps.
- You can automatically name the documents by using the scanned information.

These features allow you to save time when organizing documents.

### EPSON Software Updater

EPSON Software Updater is an application that checks for new or updated applications on the internet and installs them.

You can also update the scanner's digital manual.

### Epson DocumentScan

Epson DocumentScan is an application that allows you to scan documents through smart devices such as smartphones and tablet devices. You can save the scanned data in smart devices or cloud services, and send by e-mail. You can download and install this app from the App Store or Google Play.

### EpsonNet Config

EpsonNet Config is an application that allows you to set network interface addresses and protocols. See the operations guide for EpsonNet Config or the application's help for more details.

**Note:**

You can run Web Config from EpsonNet Config.

---

## Option Items and Consumables Information

### Carrier Sheet Codes

Using a Carrier Sheet allows you to scan irregular shaped originals. You can scan originals larger than A4 size with a Carrier Sheet by folding it in half.

Part name	Codes*
Carrier Sheet	B12B819451 B12B819471 (India only)

\* You can only use Carrier Sheet with a code.

### Maintenance Sheet Codes

Contains a Cleaning Sheet (wet type) and Cleaning Sheet (dry type) for use when cleaning inside the scanner, and a Calibration Sheet to adjust the scanned image quality.





Part name	Codes
Maintenance Sheet2	B12B819481 B12B819411 (India only)

\* You can only use Maintenance Sheet with a code.

# Using the Scanner on the Battery

## Checking the Battery Level

Check the battery level of the scanner.

Sign	Battery Level
	Full
	Middle
	Low
	Near empty

## Charging the Battery

### Battery Charging Precautions

- At the time of purchase you need to connect it to the computer with the USB cable. The battery is not fully charged. Make sure you charge the battery before you run the scanner using the battery.
- The battery slowly runs down even when you do not use the scanner. Charge the battery before you run the scanner using the battery.
- If you do not use the scanner for a long time, charge the battery once every six months on a regular basis to avoid letting it run out.
- We recommend turning off the scanner when not in use to save the battery. You can also set the scanner to turn off automatically after a specified period of time.
- The battery's usable time is shorter in low temperature environments, even if you have charged the battery fully.
- You do not need to wait for the battery to run out before charging it.
- The battery may be hot right after it is charged or used; this is normal.
- The battery cannot be charged or the battery may deteriorate if you charge it in low or high temperatures. Charge the battery within the guaranteed charging temperature range (8 to 35 °C (46 to 95 °F)).
- If the battery runs out quickly even if you are charging the battery within the guaranteed charging temperature range (8 to 35 °C (46 to 95 °F)) or even after it has been fully charged, the battery may be at the end of its service life. Contact Epson support to replace the battery.

### Charging the Battery

You can charge the battery from a computer with a USB connection.

### Using the Scanner on the Battery

1. Make sure that the computer is on. Wake the computer if it is in hibernate or sleep mode.
2. Connect the scanner to the computer using the micro USB cable.

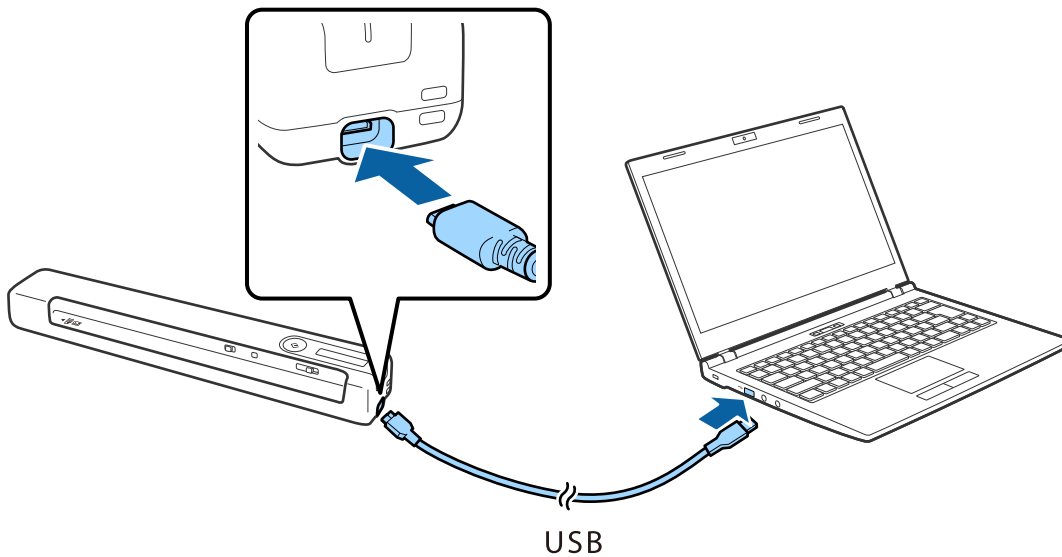

**Note:**

- ❑ Use the USB cable that came with the scanner.
- ❑ To avoid causing any damage, do not add excessive force when connecting the USB cable to the USB port.
- ❑ Connect the scanner directly to the computer without using a USB hub.
- ❑ Time until full battery charge when the scanner is off.  
USB 2.0 port: Approx. 3.5 hours\*  
\* It takes much longer to charge the battery if the scanner is on.
- ❑ If the battery is fully charged and you do not want to consume the computer's battery, disconnect the USB cable.
- ❑ Battery rated capacity: 1140 mAh (3.6 V)
- ❑ The battery light flashes when the battery is charging. When charging is complete, the light indicates full  if the scanner is on; if the scanner is off the light turns off.

# Network Settings

---

## Network Connection Types

You can use the following connection methods.

### Wi-Fi Connection

Connect the scanner and the computer or smart device to the wireless router. This is the typical connection method for home or office networks where computers are connected by Wi-Fi through the wireless router.

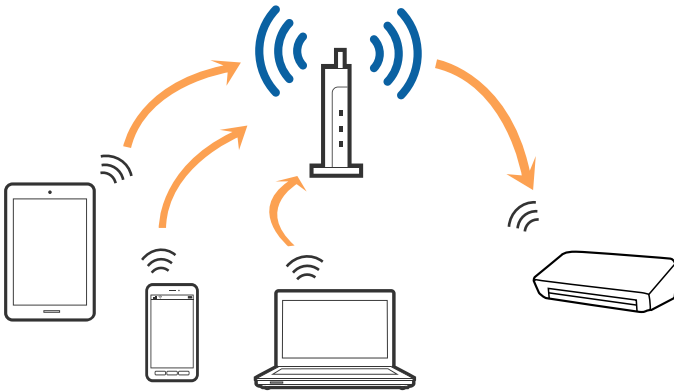

#### Related Information

- ➔ [“Connecting to a Computer” on page 19](#)
- ➔ [“Connecting to a Smart Device” on page 20](#)
- ➔ [“Making Wi-Fi Settings from the Control Panel” on page 20](#)

### Wi-Fi Direct (Simple AP) Connection

Use this connection method when you are not using Wi-Fi at home or at the office, or when you want to connect the scanner and the computer or smart device directly. In this mode, the scanner acts as a wireless router and you can connect the devices to the scanner without having to use a standard wireless router.

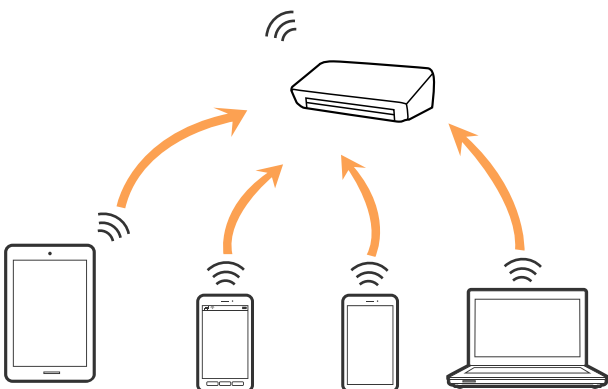

## Network Settings

The scanner can be connected by Wi-Fi and Wi-Fi Direct (Simple AP) connection simultaneously. However, if you start a network connection in Wi-Fi Direct (Simple AP) connection when the scanner is connected by Wi-Fi, the Wi-Fi is temporarily disconnected.

### Related Information

➔ “Making Wi-Fi Direct (Simple AP) Connection Settings” on page 22

---

## Connecting to a Computer

We recommend using the installer to connect the scanner to a computer. You can run the installer using one of the following methods.

Setting up from the website

Access the following website, and then enter the product name.

<http://epson.sn>

Go to **Setup**, and then click **Download** in the download and connect part. Click or double-click the downloaded file to run the installer. Follow the on-screen instructions.

Setting up using the software disc (only for the models that come with a software disc and users with computers with disc drives.)

Insert the software disc into the computer, and then follow the on-screen instructions.

### Selecting the Connection Methods

Follow the on-screen instructions until the following screen is displayed, and then select the method for connecting the scanner to the computer.

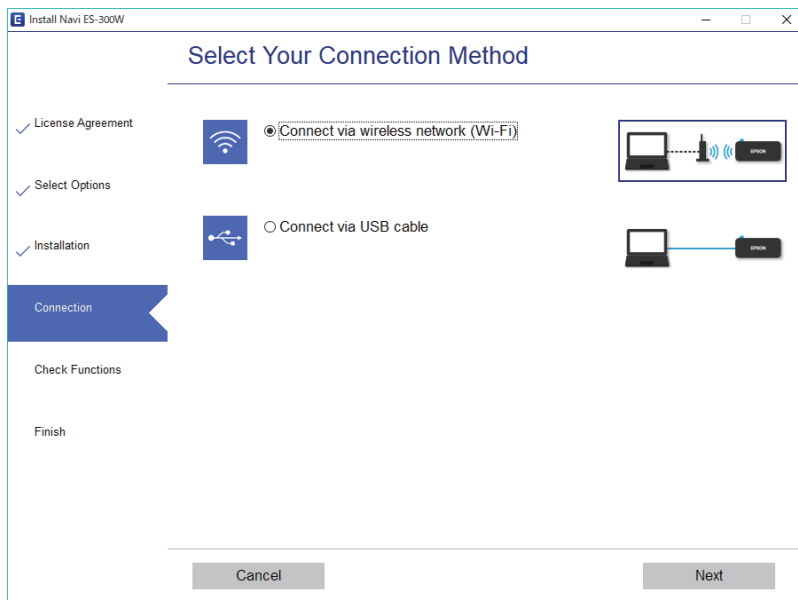

Select the connection type and then click **Next**. Follow the on-screen instructions.

---

## Connecting to a Smart Device

You can use the scanner from a smart device. To use the scanner from a smart device, set up from Epson DocumentScan.

**Note:**

*If you want to connect a computer and a smart device to the scanner at the same time, we recommend connecting the computer first.*

1. Search for Epson DocumentScan in the App Store or Google Play.
2. Download and install Epson DocumentScan.
3. Start Epson DocumentScan.
4. Follow the on-screen instructions to connect the scanner to your smart device.

---

## Making Wi-Fi Settings from the Control Panel

You can make network settings from the scanner's control panel. After connecting the scanner to the network, connect to the scanner from the device that you want to use (computer, smart phone, tablet, and so on.)

**Related Information**

- ➔ [“Making Wi-Fi Settings Using Push Button Setup \(WPS\)” on page 20](#)
- ➔ [“Making Wi-Fi Settings by PIN Code Setup \(WPS\)” on page 21](#)
- ➔ [“Making Wi-Fi Direct \(Simple AP\) Connection Settings” on page 22](#)

## Making Wi-Fi Settings Using Push Button Setup (WPS)

You can automatically set up a Wi-Fi network by pressing a button on the wireless router. If the following conditions are met, you can set up by using this method.

- The router is compatible with WPS (Wi-Fi Protected Setup).
- The current Wi-Fi connection was established by pressing a button on the router.

1. Make sure that the scanner is turned on.
2. Set the  switch on the scanner to on.

## Network Settings

3. Hold down the WPS button on the router until the security light flashes.



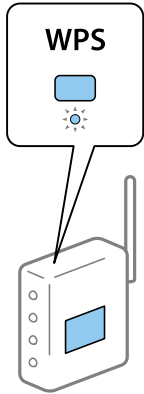

**Important:**

*You must complete Wi-Fi connection setup within two minutes.*





If your router does not have a WPS button, see your router documentation for instructions on enabling WPS in your router's software.

4. Hold down the  button on the scanner until the Ready light flashes, and  and  lights flash alternately (approximately 3 seconds).

When the Ready light,  and  lights stay on, connection is complete.

**Note:**

*Connection has failed when the Ready light stays on,  and  lights flash simultaneously. Restart the scanner and the router, move them closer together, and then try again.*

### Related Information



- ➔ [“Basic Scanning” on page 37](#)
- ➔ [“Advanced Scanning” on page 46](#)
- ➔ [“Network Problems” on page 68](#)

## Making Wi-Fi Settings by PIN Code Setup (WPS)

You can automatically connect to a wireless router by using a PIN code. You can use this method to setup if the router supports WPS (Wi-Fi Protected Setup). Use a computer to enter a PIN code into the router.

1. Make sure that the scanner is turned off.
2. Set the  switch on the scanner to on.



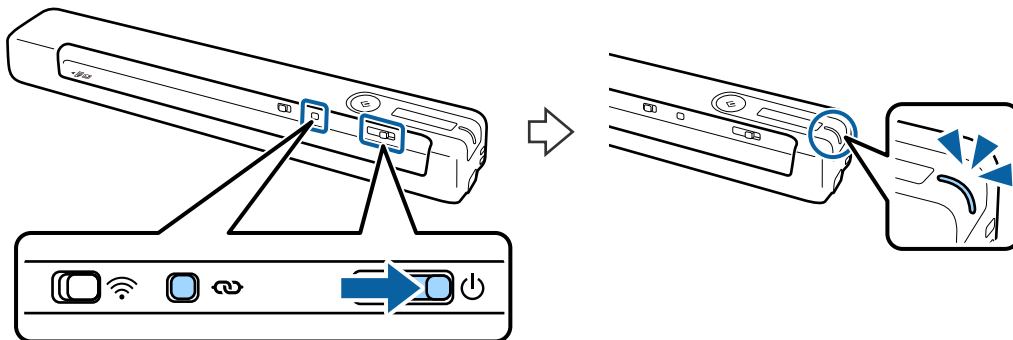

## Network Settings

- Slide the  switch while holding down the  button and hold them there for approximately 10 seconds until the ready light flashes to turn on the scanner.





### **Important:**

*You must complete Wi-Fi connection setup within two minutes.*

- Use your computer to enter the PIN code (an eight-digit number) on the label stuck to the scanner.  
Connection setup starts. The Ready light flashes, and the  and  lights on the scanner flash alternately.  
When the Ready light,  and  lights stay on, connection is complete.

### **Note:**

- For details on entering a PIN code, see your router documentation for instructions.
- Connection has failed when the Ready light stays on,  and  lights flash simultaneously. Restart the scanner and the router, move them closer together, and then try again.

### **Related Information**

- ➔ [“Basic Scanning” on page 37](#)
- ➔ [“Advanced Scanning” on page 46](#)
- ➔ [“Network Problems” on page 68](#)

## Making Wi-Fi Direct (Simple AP) Connection Settings

This method allows you to connect the scanner directly to devices without a wireless router. The scanner acts as a router.

### **Important:**

*When you connect from a smart device to the scanner using a Wi-Fi Direct (Simple AP) connection, the scanner is connected to the same Wi-Fi network (SSID) as the smart device and communication is established between them. Since the smart device automatically connects to other connectable Wi-Fi networks when the scanner is turned off, it does not connect to the previous Wi-Fi network again when the scanner is turned on. Connect to the scanner's SSID in Wi-Fi Direct (Simple AP) from the smart device again. If you do not want to connect every time you turn the scanner on or off, we recommend using a Wi-Fi network by connecting the scanner to a router.*

- Set the  switch on the scanner to on.

## Network Settings

2. Make sure that the scanner is turned on.
3. Connect from the smart device or computer to the scanner using the scanner's SSID and password.

**Note:**

- You can check the SSID and password on the label stuck to the scanner.
- It may take a few minutes for the scanner SSID to appear in the list.
- See the documentation provided with your smart device or computer for the operating instructions.

### Related Information

- ➔ “Basic Scanning” on page 37
- ➔ “Advanced Scanning” on page 46
- ➔ “Network Problems” on page 68

---

## Checking the Network Status Using Network Light

You can check the network connection status using the network light on the scanner's control panel.

### Related Information

- ➔ “Buttons and Lights” on page 11
- ➔ “Error Indicators” on page 13

---

## Replacing or Adding New Wireless Routers

If the SSID changes due to the replacement of a wireless router, or a wireless router is added and a new network environment is established, re-set the Wi-Fi settings.

### Related Information

- ➔ “Changing the Connection Method to a Computer” on page 23

---

## Changing the Connection Method to a Computer

Using the installer and re-set up in a different connection method.

- Setting up from the website

Access the following website, and then enter the product name.

<http://epson.sn>

Go to **Setup**, and then click **Download** in the download and connect part. Click or double-click the downloaded file to run the installer. Follow the on-screen instructions.

- Setting up using the software disc (only for the models that come with a software disc and users with computers with disc drives.)

Insert the software disc into the computer, and then follow the on-screen instructions.

## Network Settings

### Selecting Change the Connection Methods

Follow the on-screen instructions until the following screen is displayed.

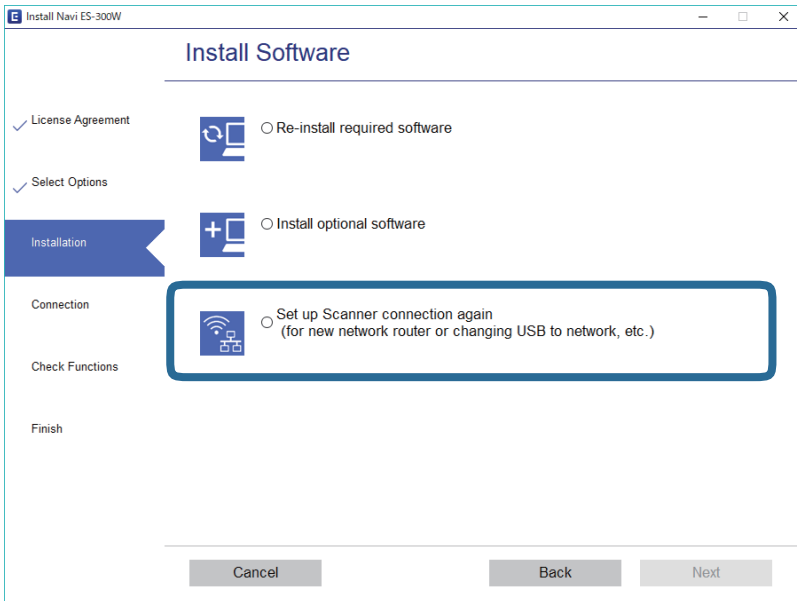

Select **Set up Scanner connection again (for new network router or changing USB to network, etc.)** on the Install Software screen, and then click **Next**. Follow the on-screen instructions.

---

## Disabling the Wi-Fi

Slide the  switch to the left on the scanner to switch off the Wi-Fi.



---

## Restoring the Network Settings from the Control Panel

You can restore all network settings to their defaults.

1. Make sure that the scanner is turned off.
2. Set the  switch on the scanner to on.

## Network Settings

- Slide the  switch while holding down the  and  buttons and hold them there for approximately 10 seconds to turn on the scanner.

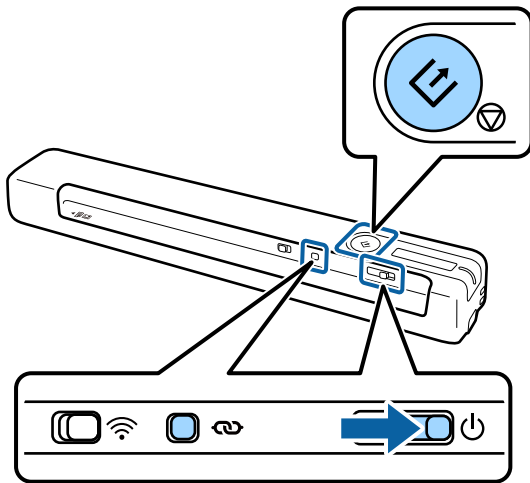

The  and  lights flash alternately and the Ready light flashes.

- The network settings are restored to their defaults when the lights stop flashing. The scanner restarts automatically.

# Specifications of Originals and Placing Originals

## Specifications of Originals

This section explains the specifications and conditions of originals that can be loaded in the scanner.

### General Specifications for Originals being Scanned

#### Specifications of Standard Size Originals

These are the specifications for standard size originals that you can load into the scanner.

Size	Measurement	Thickness	Paper Type
A4	210×297 mm (8.3×11.7 in.)	35 to 270 g/m <sup>2</sup>	Plain paper Fine paper Recycled paper
Letter	215.9×279.4 mm (8.5×11 in.)		
Legal	215.9×355.6 mm (8.5×14 in.)		
B5	182×257 mm (7.2×10.1 in.)		
A5	148×210 mm (5.8×8.3 in.)		
B6	128×182 mm (5.0×7.2 in.)		
A6	105×148 mm (4.1×5.8 in.)	46 to 270 g/m <sup>2</sup>	
A7	74×105 mm (2.9×4.1 in.)		
A8	52×74 mm (2.1×2.9 in.)		
Business Card	55×89 mm (2.1×3.4 in.)		

### Specifications of Originals and Placing Originals

Size	Measurement	Thickness	Paper Type
Post Cards	100×148 mm (3.9×5.8 in.)	35 to 270 g/m <sup>2</sup>	Plain paper Fine paper Recycled paper

**Note:**

- ❑ All originals must be flat at the leading edge.
- ❑ Make sure that curls on the leading edge of the originals are kept within the following range.  
 ① and ② must be 2 mm or less when ③ is equal to or more than 30 mm.

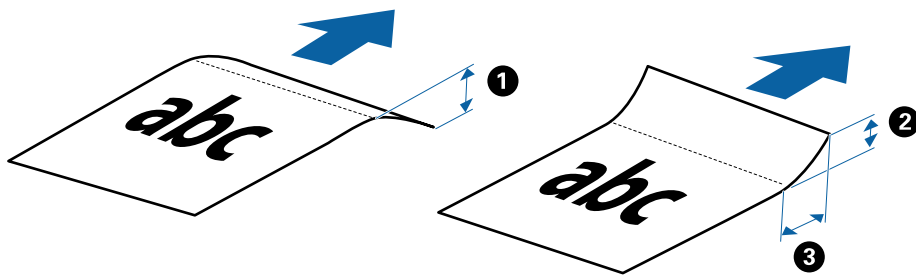

### Specifications of Long Paper

These are the specifications for long paper that you can load into the scanner.

Size	Thickness	Paper Type
Width: 50.8 to 216.0 mm (2.0 to 8.5 in.) Length: 50.8 to 1828.8 mm (2.0 to 72.0 in.)	35 to 270 g/m <sup>2</sup>	Plain paper Fine paper Recycled paper

### Specifications for Receipts

These are the specifications for receipts that you can load into the scanner.

Size	Thickness	Paper Type
Maximum: 76.2×355.6 mm (3.0×14.0 in.) Minimum: 76.2×76.2 mm (3.0×3.0 in.)	46 to 270 g/m <sup>2</sup>	Plain paper Fine paper Recycled paper

\* Receipts need to be scanned using Automatic Feeding Mode. Only one receipt should be loaded at once and you need to hold the receipt for a good quality scan.

### Specifications of Envelopes

These are the specifications for envelopes that you can load into the scanner.

## Specifications of Originals and Placing Originals

Measurement	Thickness
120×235 mm (4.72×9.25 in.)	0.38 mm (0.015 in.) or less
92×165 mm (3.62×6.50 in.)	

### Specifications for Plastic Cards

These are the specifications for plastic cards that you can load into the scanner.

Size	Card Type	Thickness	Loading Direction
ISO7810 ID-1 Type 54.0×85.6 mm (2.1×3.3 in.)	With embossing	1.24 mm (0.05 in.) or less	Horizontal (landscape)
	Without embossing	1.0 mm (0.04 in.) or less	

**Note:**

ISO7810 ID-1 size laminated cards (the thickness should be 0.6 mm (0.02 in.) or less) may not be scanned successfully.

### Specifications of Irregular Shaped Originals

By using the Carrier Sheet, you can scan originals that are wrinkled, curled, very thin, or irregularly shaped.

Size	Thickness
Up to A4	0.3 mm (0.012 in.) or less (excluding the thickness of the Carrier Sheet)

## Types of Originals that Require Attention

The following types of originals may not be successfully scanned.

- Originals with an uneven surface such as letter head paper
- Originals with crinkles or fold lines
- Curled originals
- Coated paper
- Originals with punch holes
- Originals with folded corners

**Note:**

- To scan delicate originals or originals that are easily crinkled, use the Carrier Sheet.
- Try to flatten the curled originals before scanning.

## Types of Originals that Must Not be Scanned

The following types of originals must not be scanned.

- Photos\*
- Photo paper\*

## Specifications of Originals and Placing Originals

- Original with labels or stickers\*
- Originals with sticky notes attached\*
- Ripped originals\*
- Originals with carbon paper on the back\*
- Perforated originals\*
- Originals with staples or paper clips
- Booklets
- Non-paper original (such as clear files, fabric, and metal foil)
- Originals with glue attached
- Heavily wrinkled or curled originals
- Transparent originals such as OHP film
- Originals with wet ink

**Note:**

- \*You can only scan these originals by using the Carrier Sheet.
- Do not feed photos, valuable original artwork, or important documents that you do not want to damage or deface into the scanner directly. Misfeeding may wrinkle or damage the original. When scanning such originals, make sure you use the Carrier Sheet.

---

## Placing the Original

### Placing Standard Size Originals

Load the original into the left side of input slot facing up with the top edge facing into the scanner.

Slide the original into the input slot until it meets resistance.

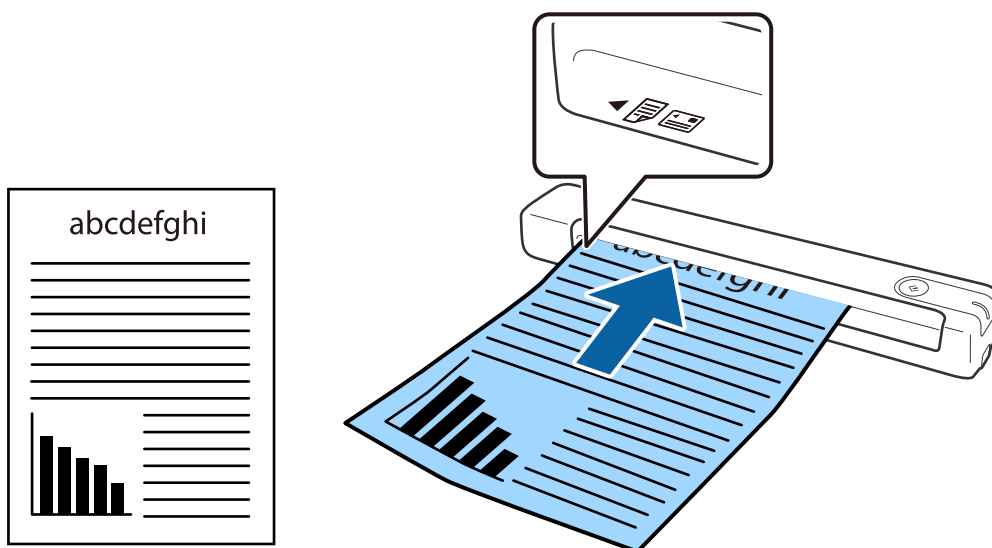

**Note:**

We recommend loading originals (except plastic card) vertically into the scanner.

## Specifications of Originals and Placing Originals

### Related Information

- ➔ [“Basic Scanning” on page 37](#)
- ➔ [“Advanced Scanning” on page 46](#)

## Placing Long Paper

Load the original straight into the left side of the input slot, facing up with the top edge facing into the scanner. Slide the original into the input slot until it meets resistance.

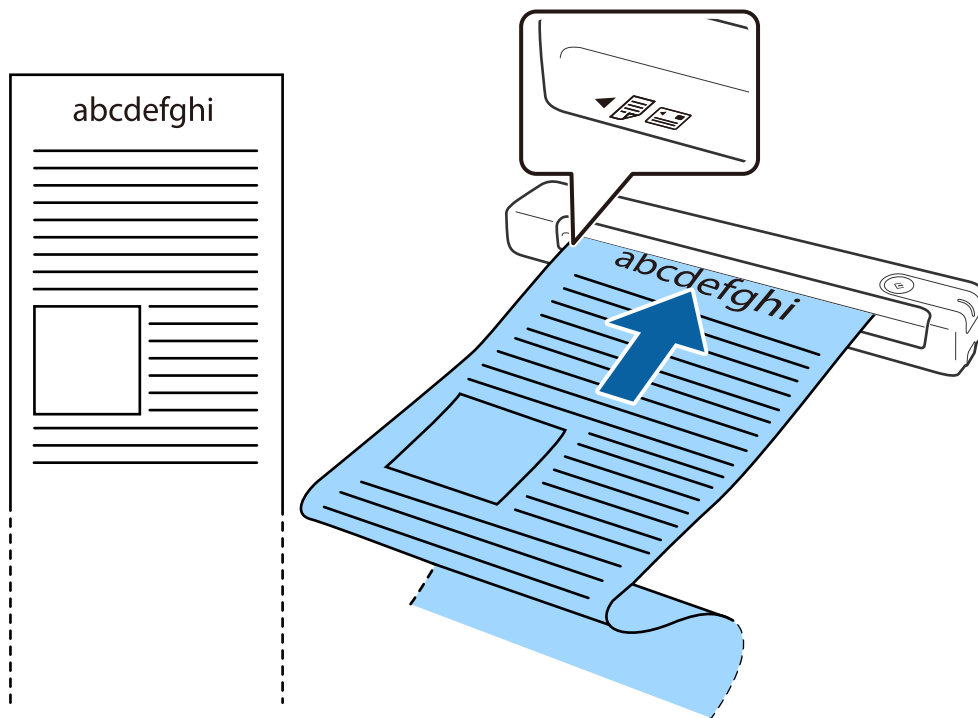

## Specifications of Originals and Placing Originals

### Note:

- ❑ You can scan long paper up to 1,828.8 mm (72 inches) in length with a resolution of 300 dpi or less.
- ❑ You need to specify the paper size in Epson ScanSmart.

Click  **Settings** in **Epson ScanSmart**, **Review Scans** or on the **Select Action** window, and then click the **Scanner Settings** tab > **Scan Settings** button to open the Epson Scan 2 window.

There are three ways to specify the paper size. If the paper length is 863.6 mm (34 inches) or less, you can select **Auto Detect (Long Paper)** to detect the size automatically.

If the paper length is more than 863.6 mm (34 inches), you need to select **Customize** and enter the size of the paper.

You can either enter the width and height of the paper or use **Detect paper length** instead of entering the paper height.

- ❑ Support the long paper on the input side so that it does not drop out of the input slot, and on the output side so that the ejected paper does not fall from the output slot.

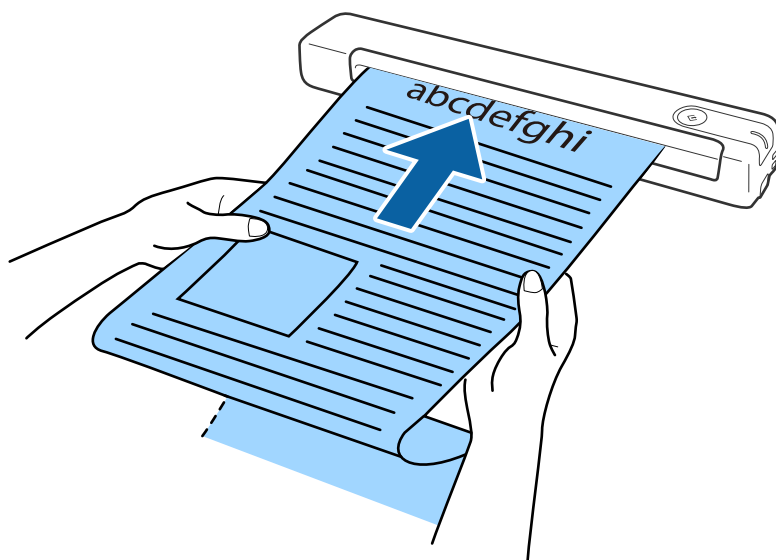

### Related Information

- ➔ [“Specifications of Originals” on page 26](#)
- ➔ [“Basic Scanning” on page 37](#)
- ➔ [“Advanced Scanning” on page 46](#)

## Placing Receipts

Supporting it by hand, load the receipt straight into the left side of the input slot, facing up with the top edge facing into the scanner.

## Specifications of Originals and Placing Originals

Slide the receipt into the input slot until it meets resistance.

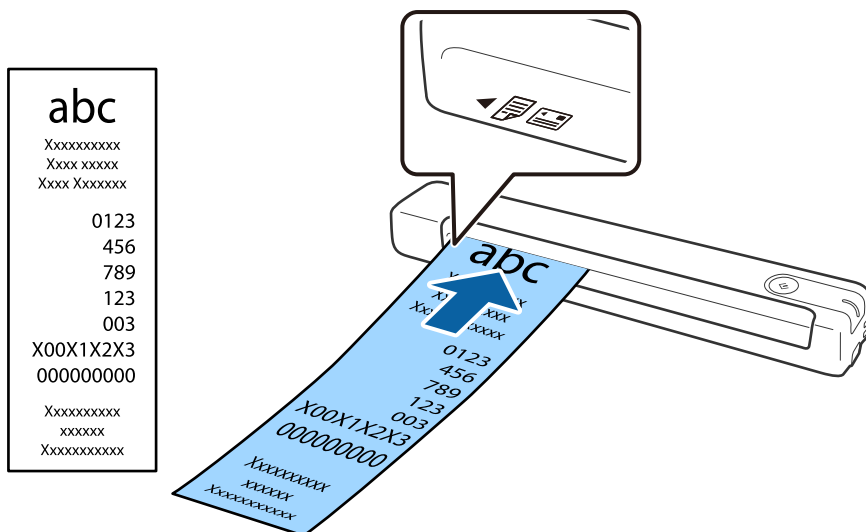

### Note:

- Although there may be issues with the scanning quality, you can scan long receipts up to 1,828.8 mm (72 inches) in length at a resolution of 300 dpi.
- You need to specify the paper size in Epson ScanSmart.

Click  **Settings** in **Epson ScanSmart**, **Review Scans** or on the **Select Action** window, and then click the **Scanner Settings** tab > **Scan Settings** button to open the Epson Scan 2 window.

There are three ways to specify the paper size. If the paper length is 863.6 mm (34 inches) or less, you can select **Auto Detect (Long Paper)** to detect the size automatically.

If the paper length is more than 863.6 mm (34 inches), you need to select **Customize** and enter the size of the paper.

You can either enter the width and height of the paper or use **Detect paper length** instead of entering the paper height.

### Related Information

- ➔ [“Scanning Different Sizes or Types of Originals One by One Continuously \(Automatic Feeding Mode\)” on page 46](#)
- ➔ [“Specifications of Originals” on page 26](#)
- ➔ [“Basic Scanning” on page 37](#)
- ➔ [“Advanced Scanning” on page 46](#)

## Placing Envelopes

Load envelopes into the left side of the input slot facing up making sure that the opened edge (flap side) of the envelope is facing to the side. For envelopes with the opened edge (flap side) on the shorter side, you can load the envelope with the bottom edge (non flap side) facing into the scanner.

## Specifications of Originals and Placing Originals

Slide the envelope into the input slot until it meets resistance.

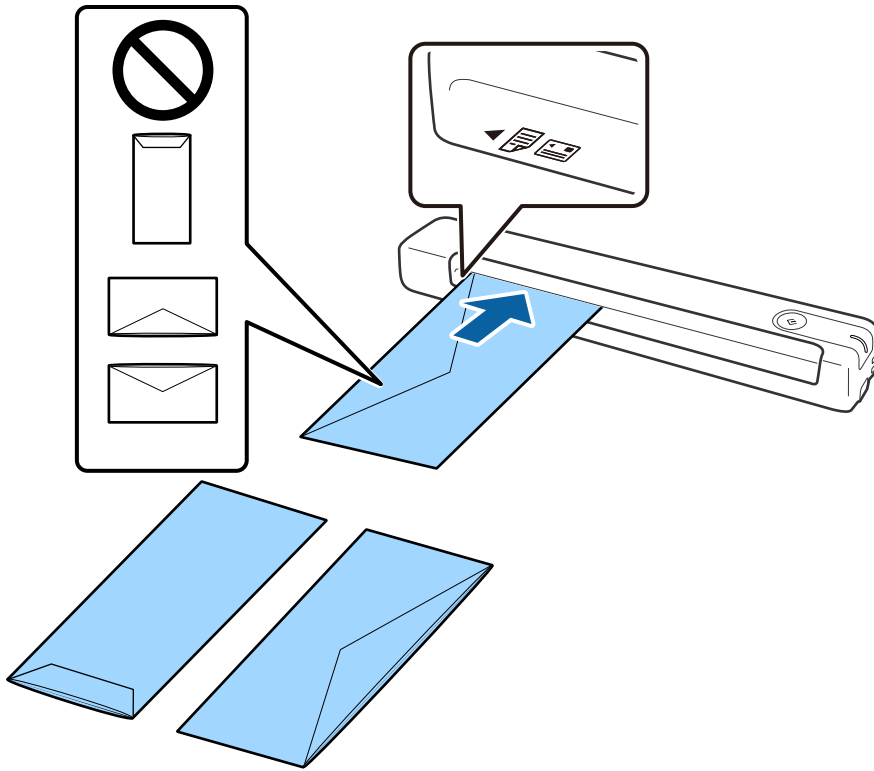

The envelope shown in the illustration has the opened edge (flap side) facing up, but you can also load envelopes into the scanner with the opened edge (flap side) facing down.



**Important:**

*Do not load envelopes with adhesives on them.*

**Note:**

- Envelopes that are not opened by cutting sharply at the flap edge may not be scanned correctly.
- Envelopes that have not yet been sealed can be loaded with the flap open and facing up.

**Related Information**

- ➔ [“Specifications of Originals” on page 26](#)
- ➔ [“Basic Scanning” on page 37](#)
- ➔ [“Advanced Scanning” on page 46](#)

## Placing Plastic Cards

Load the plastic card into the left side of the input slot facing up and horizontally.

## Specifications of Originals and Placing Originals

Slide the plastic card straight into the input slot until it meets resistance.

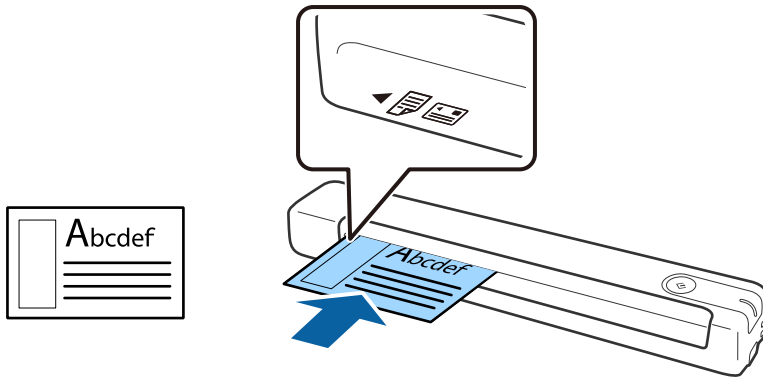

**!** *Important:*

*Do not load plastic cards vertically or at an angle.*

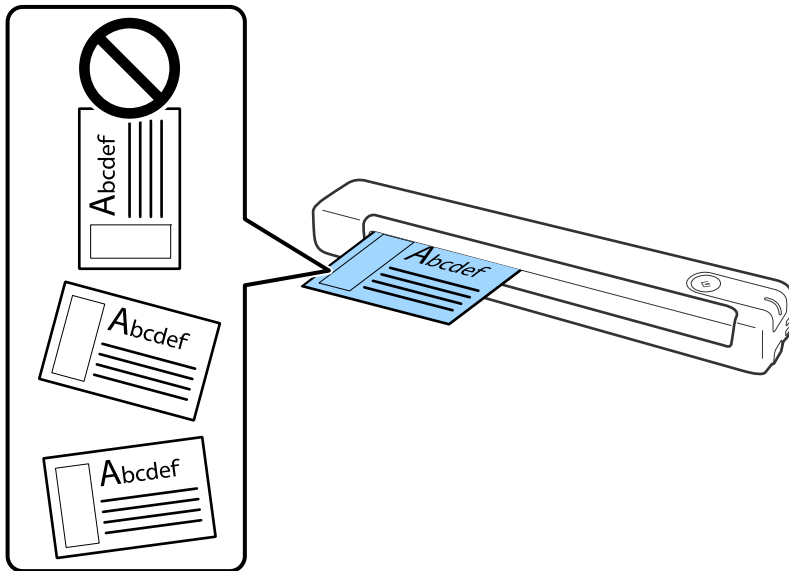

### Related Information

- ➔ [“Specifications of Originals” on page 26](#)
- ➔ [“Basic Scanning” on page 37](#)
- ➔ [“Advanced Scanning” on page 46](#)

## Specifications of Originals and Placing Originals

### Placing Irregular Shaped Originals

1. Place the Carrier Sheet with the illustration on the front edge facing up and place the original in the left side of the Carrier Sheet with the side to be scanned facing up.

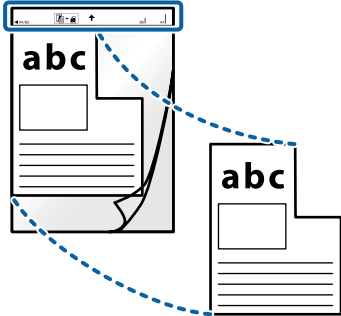

2. Load the Carrier Sheet into the left side of input slot with the top edge facing into the scanner. Slide the Carrier Sheet into the input slot until it meets resistance.

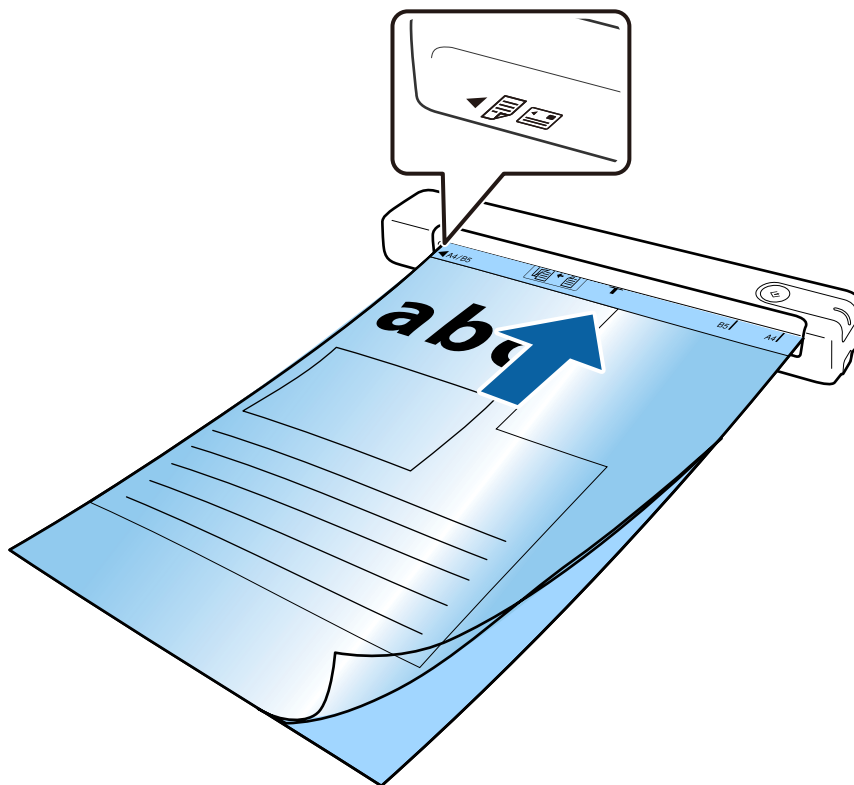

## Specifications of Originals and Placing Originals

**Note:**

- You may need to stop using a Carrier Sheet that is scratched or has been scanned more than 3,000 times.
- If you cannot find an appropriate size for the original you want to scan in **Document Size**, try changing the setting.

Click  **Settings** in **Epson ScanSmart**, **Review Scans**, or on the **Select Action** window, click the **Scanner Settings** tab > **Scan Settings** button > **Document Size** on the Epson Scan 2 window, and then select **Auto Detect** or **Customize** to create a custom document size.

When scanning a Carrier Sheet by selecting **Auto Detect** as the **Document Size** setting, the image is automatically scanned by applying **Paper Skew** as the **Correct Document Skew** setting.

- Only use the Carrier Sheet designed for your scanner.



# Basic Scanning

---

## Scanning Using a Scanner Button

You can scan using the button on your scanner.

**Note:**

- ❑ *Make sure that Epson ScanSmart is installed on your computer and the scanner is connected to your computer correctly.*
- ❑ *If a computer is connected to the scanner by USB while another computer is also connected to the scanner over a wireless connection, scanned images are saved to the USB connected computer when you press the scanner button.*

1. Place the originals on your scanner.
2. Press the  button on the scanner.  
Scanning starts and Epson ScanSmart opens.

### Related Information

- ➔ [“Specifications of Originals and Placing Originals” on page 26](#)
- ➔ [“Buttons and Lights” on page 11](#)
- ➔ [“Epson ScanSmart” on page 14](#)

---

## Scanning and Saving Documents

This section explains how to scan and save to a PDF file.

See the Epson ScanSmart help for details on how to use the application.

1. Place the originals on your scanner.
2. Start Epson ScanSmart and then click **SCAN**.
  - ❑ Windows 10  
Click the start button, and then select **Epson Software > Epson ScanSmart**.
  - ❑ Windows 8.1/Windows 8  
Enter the application name in the search charm, and then select the displayed icon.
  - ❑ Windows 7  
Click the start button, and then select **All Programs > Epson Software > Epson ScanSmart**.

## Basic Scanning

- ❑ Mac OS

Select **Go > Applications > Epson Software > Epson ScanSmart**.

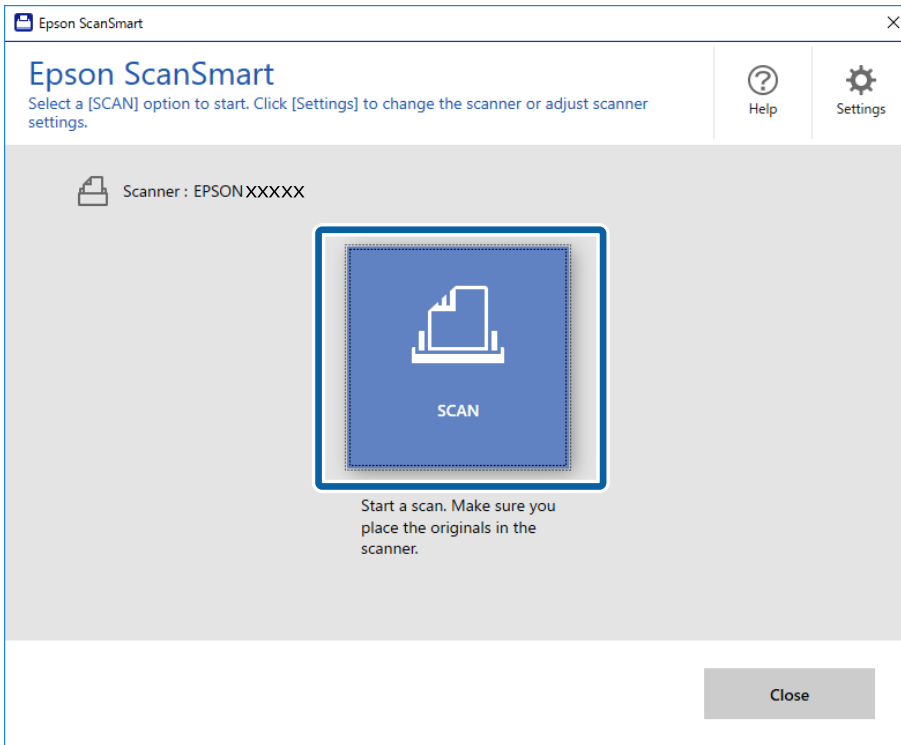

3. Check the scanned images, and organize them if necessary.

- ❑ You can also scan and add originals from **Scan more**.
- ❑ You can use the buttons at the top of the screen to rotate or delete scanned images.
- ❑ If you do not want to organize scanned images each time, select **Skip this screen next time**.

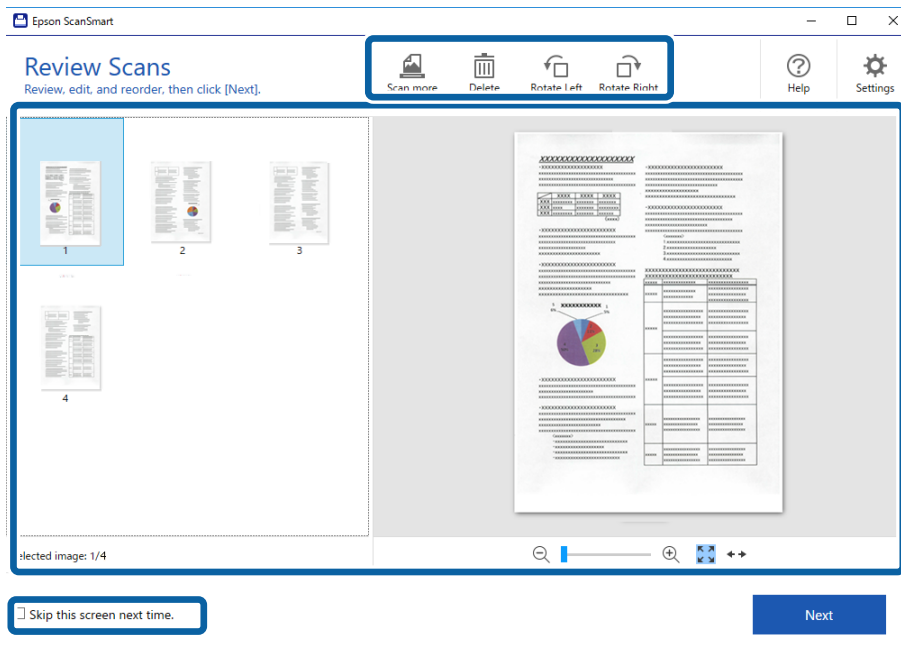

## Basic Scanning

- Click **Next**.

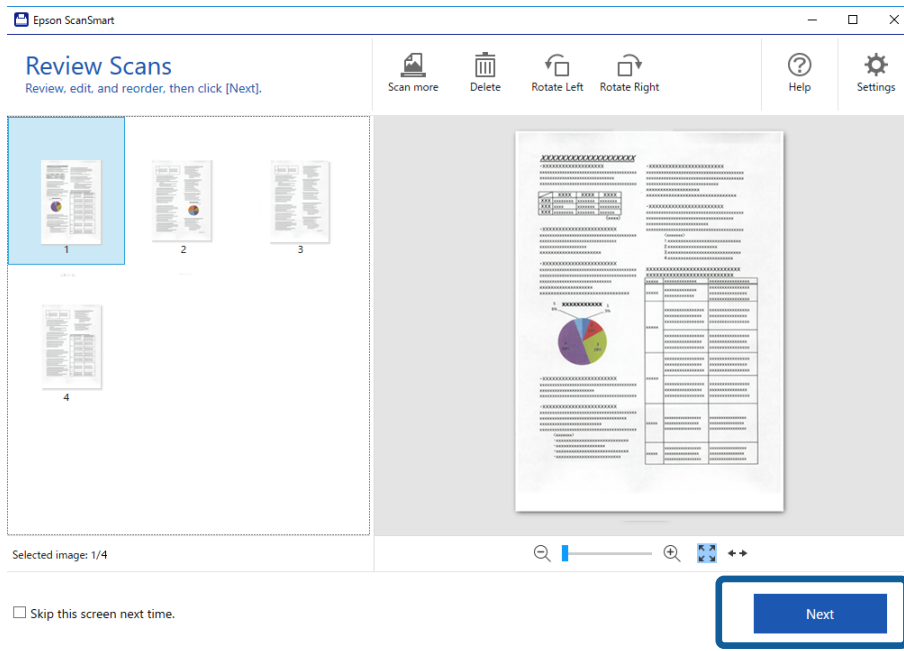

- Click **Save** on the **Select Action** window.

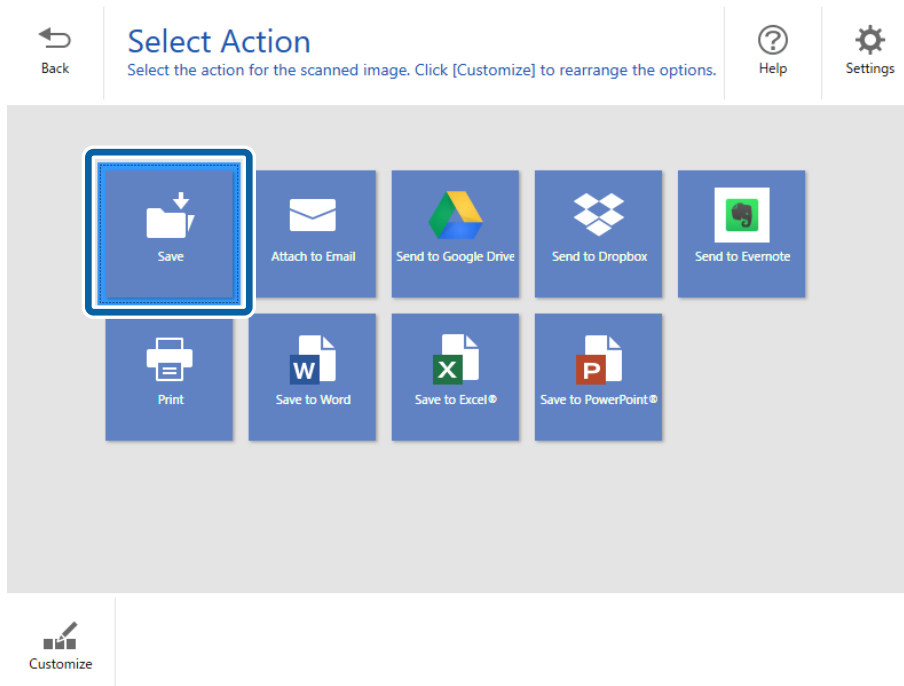

- Check or change the settings as necessary.  
The file is named automatically by detecting the date and subject.

## Basic Scanning

The folder is also named automatically by detecting the subject in the original.

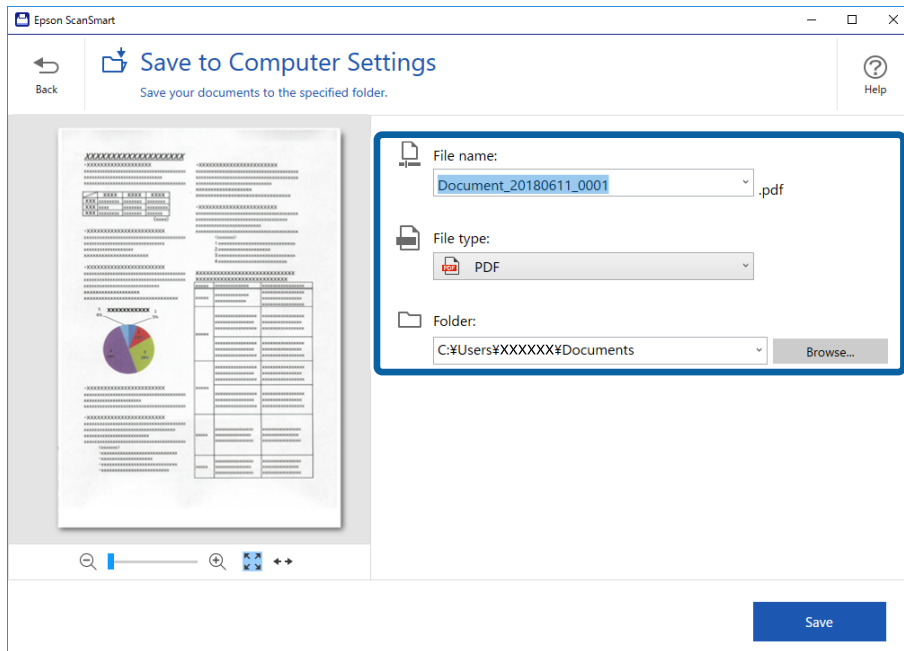

**Note:**

- You can change the file naming methods. Click **Back** to return to the **Select Action** window, and then click **Settings**. Click the **File Name Settings** tab to change the file naming methods.
- Check the following if the scanner detects a different date or subject.
  - The original has been placed straight into the input slot.
  - The original has clear text.
- When you select **Searchable PDF** as the **File type** setting, the **Language** list box is displayed. Select **Other languages** and then select the languages from the list on the **OCR Language** window.

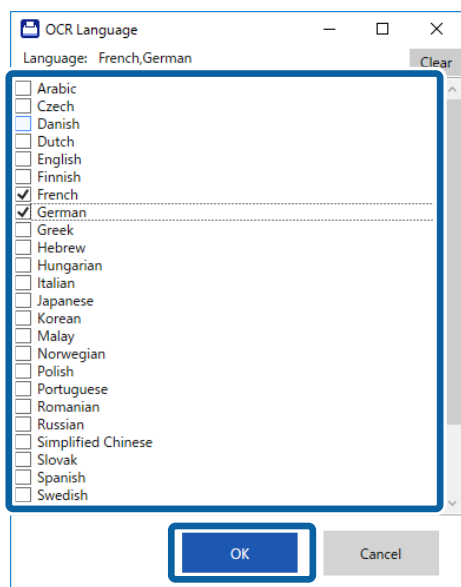

## Basic Scanning

7. Click **Save**.

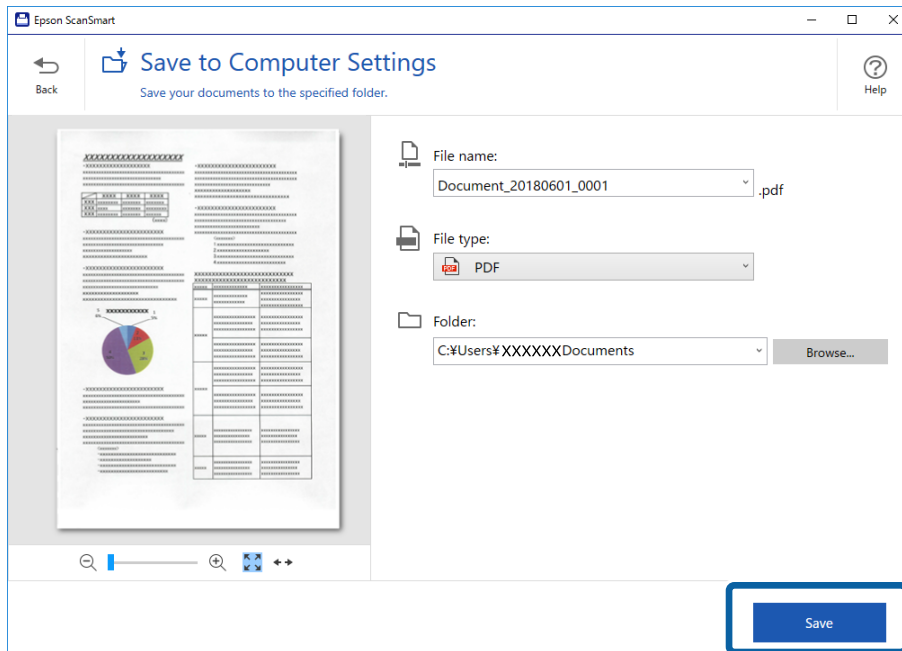

The scanned image is saved to the specified folder.

### Related Information

- ➔ [“Specifications of Originals and Placing Originals” on page 26](#)
- ➔ [“Epson ScanSmart” on page 14](#)

---

## Scanning Using Epson DocumentScan

### Note:

Connect the scanner to the smart device before scanning.

1. Place the original.
2. Start Epson DocumentScan.

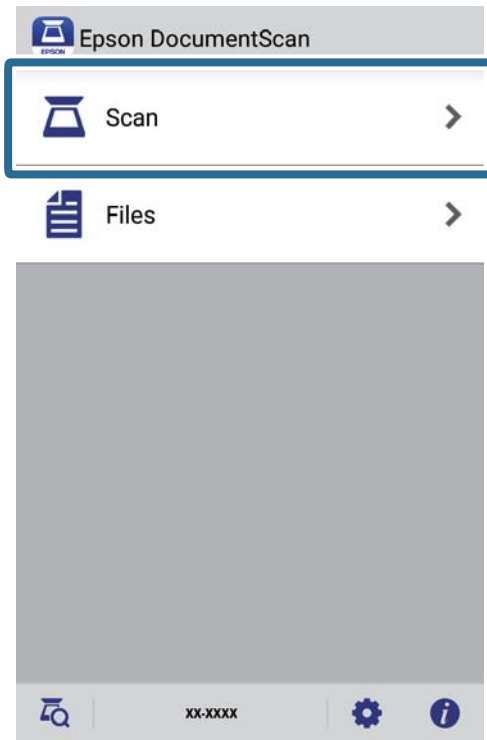
3. Tap **Scan**.

## 4. Make the scan settings.



- Document Size:** Select the size of the original you placed.
- Image Type:** Select the color for saving the scanned image.
- Resolution:** Select the resolution.

## Basic Scanning

- ❑ **Scanning Side:** Select the side of the original you want to scan.
- ❑ **Image Format:** Select the save format from the list.
- ❑ **Location:** Select the location to save the scanned image.
- ❑ **File Name:** Check the settings for the file name.

5. Tap **Scan**.

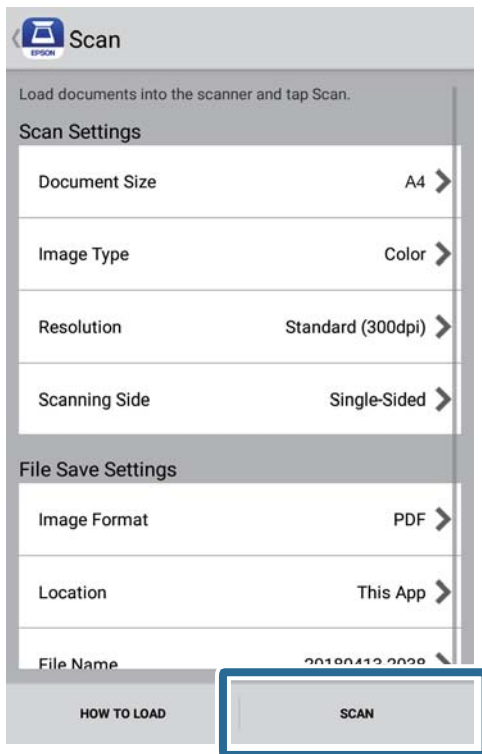

Scanning starts.

### Basic Scanning

6. Check the scanned image, and then tap **Done**.

**Note:**

To continue scanning, tap **Scan More**.

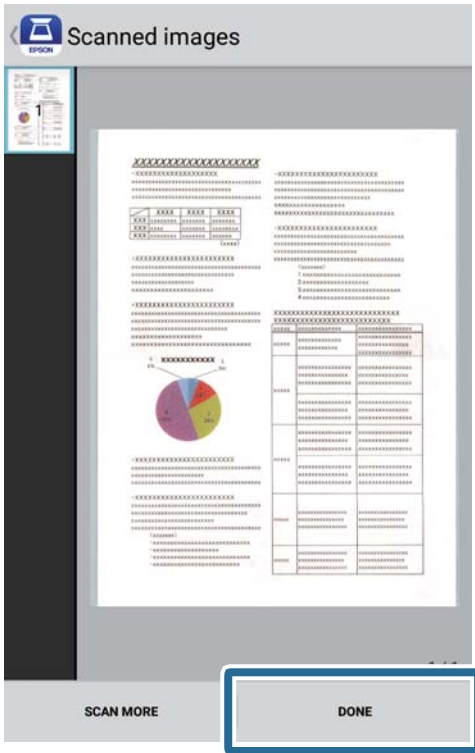

7. Tap **Save**.

**Note:**

You can rotate and sort the images by tapping the icons on the bottom of the screen.

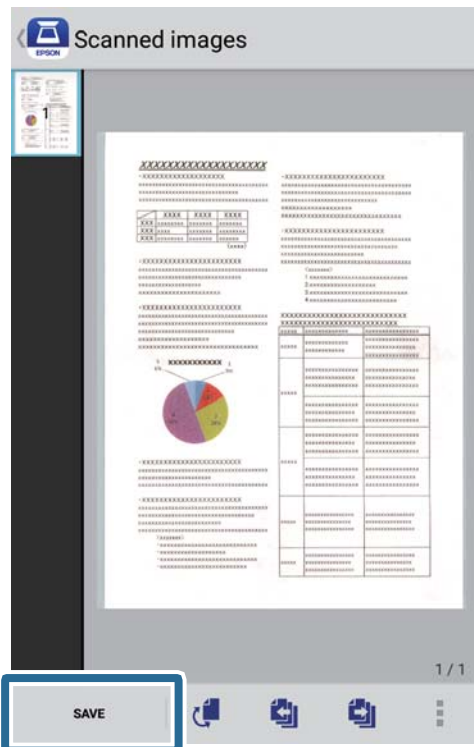

## Basic Scanning

The scanned image is saved to your storage device.

# Advanced Scanning

## Scanning Different Sizes or Types of Originals One by One Continuously (Automatic Feeding Mode)

You can scan different sizes or types of originals one by one using Automatic Feeding Mode. In this mode, the scanner starts scanning automatically when originals are loaded into the scanner.

1. Start Epson ScanSmart.
  - Windows 10  
Click the start button, and then select **Epson Software > Epson ScanSmart**.
  - Windows 8.1/Windows 8  
Enter the application name in the search charm, and then select the displayed icon.
  - Windows 7  
Click the start button, and then select **All Programs > Epson Software > Epson ScanSmart**.
  - Mac OS  
Select **Go > Applications > Epson Software > Epson ScanSmart**.
2. Click  **Settings** in **Epson ScanSmart**, **Review Scans** or on the **Select Action** window.
3. Click **Scan Settings** on the **Scanner Settings** tab.

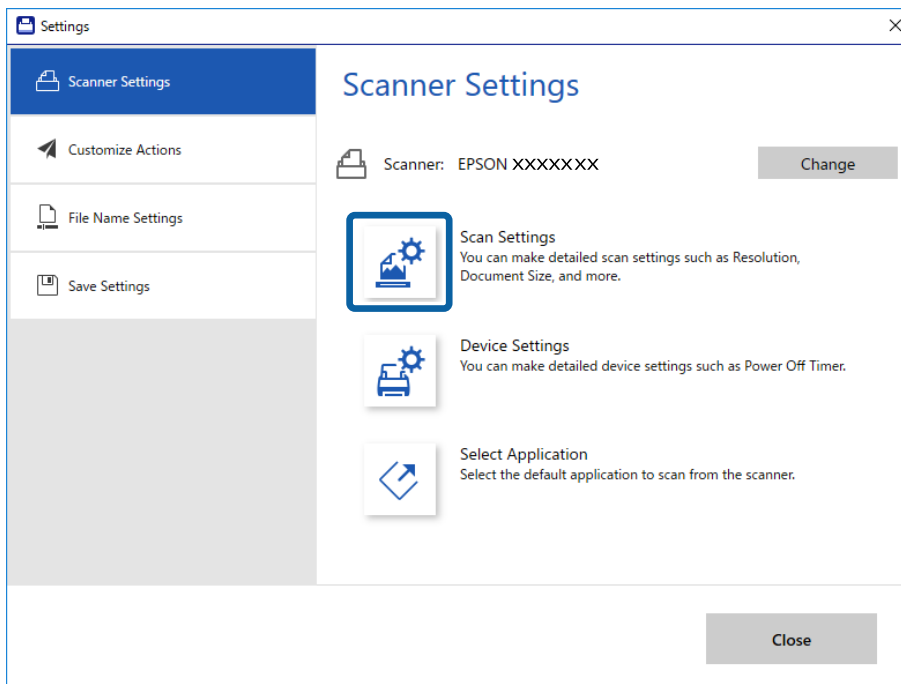

## Advanced Scanning

4. The **Epson Scan 2** window is displayed.  
Select **Automatic Feeding Mode** on the **Main Settings** tab.

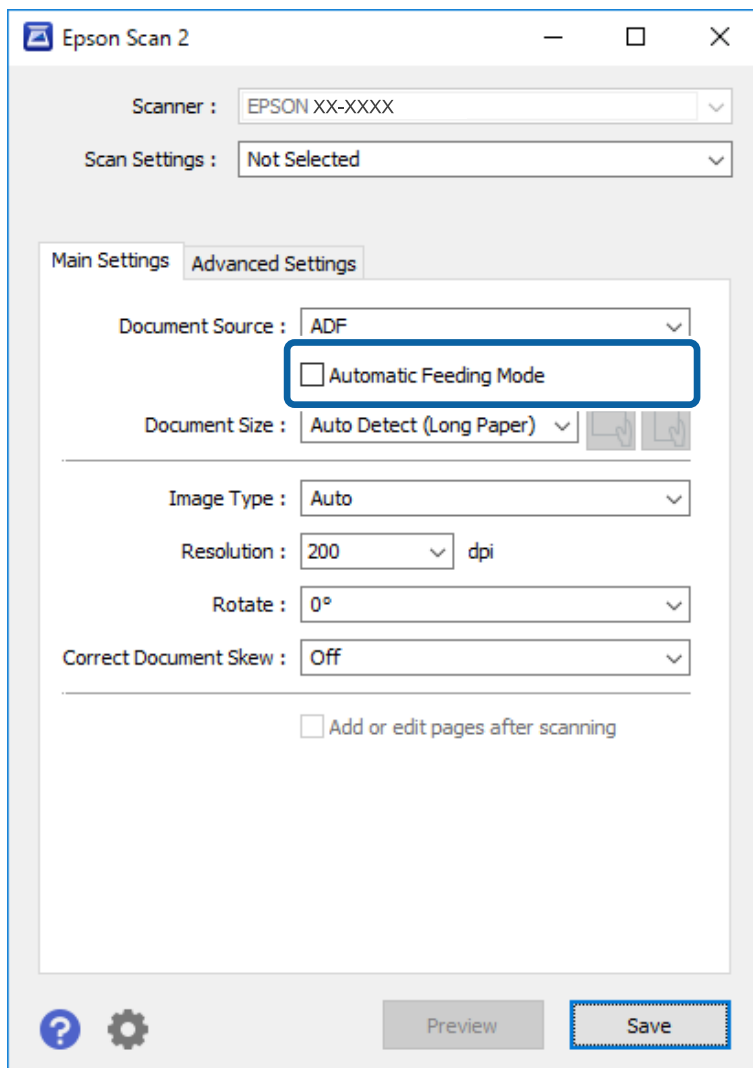

5. Make other settings for scanning on the Epson Scan 2 main window.
6. Click **Save** and close the Settings window.
7. Place the original into the scanner until it is fed automatically.
8. Click **SCAN**.  
Automatic Feeding Mode starts.

## Advanced Scanning

The  light on the scanner turns on, and the **Automatic Feeding Mode** window is displayed on your computer.

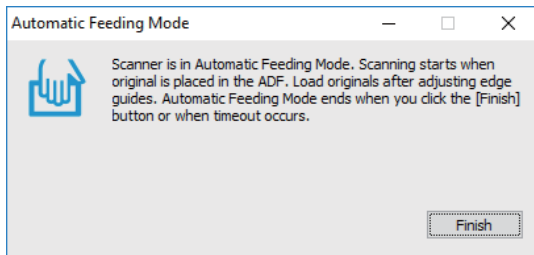

9. After scanning stops, place the next original into the scanner.  
Repeat this procedure until you have scanned all originals.
10. After you have scanned all originals, press the  button on the scanner to close Automatic Feeding Mode.

**Note:**

- You can also close Automatic Feeding Mode by pressing **Finish** on the **Automatic Feeding Mode** window displayed on your computer.
- You can make timeout settings to finish **Automatic Feeding Mode**.  
Select **Settings** on the **Document Source** list to open the **Document Source Settings** window. Set **Automatic Feeding Mode Timeout (minutes)** on the window.

The scanned image is saved to the folder you specified.

### Related Information

- ➔ [“Specifications of Originals and Placing Originals” on page 26](#)

---

## Saving as Editable Files (Microsoft® Office)

You can save in the following Microsoft® Office formats.

- Microsoft® Word
- Microsoft® Excel®
- Microsoft® PowerPoint® (Windows only)

1. Place the originals on your scanner.
2. Press the  button on the scanner to start scanning and open Epson ScanSmart.

**Note:**

- If you cannot start scanning from the  button on the scanner, see link in Related Information at the end of the chapter.
  - You can also start scanning from your computer.  
Start **Epson ScanSmart**, and then click **SCAN**.
3. Check the scanned image and click **Next**.

## Advanced Scanning

4. Select where you want to save the data.

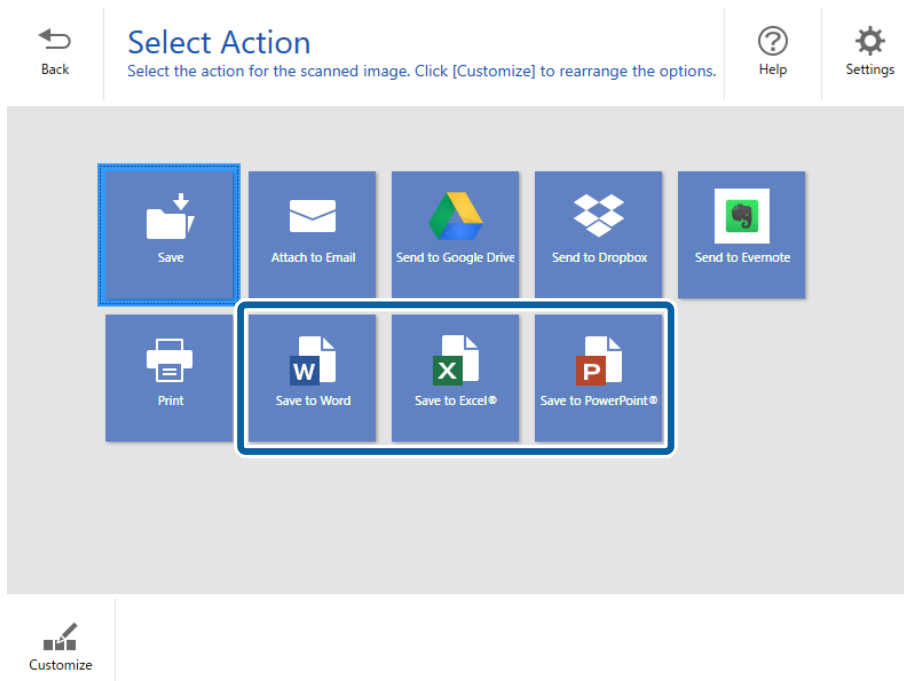

**Note:**

- If the screen for adding the Microsoft® Office plug-in is displayed, click **OK**.
- Save to PowerPoint®** is not available for Mac OS.

5. Check or change the settings as necessary.

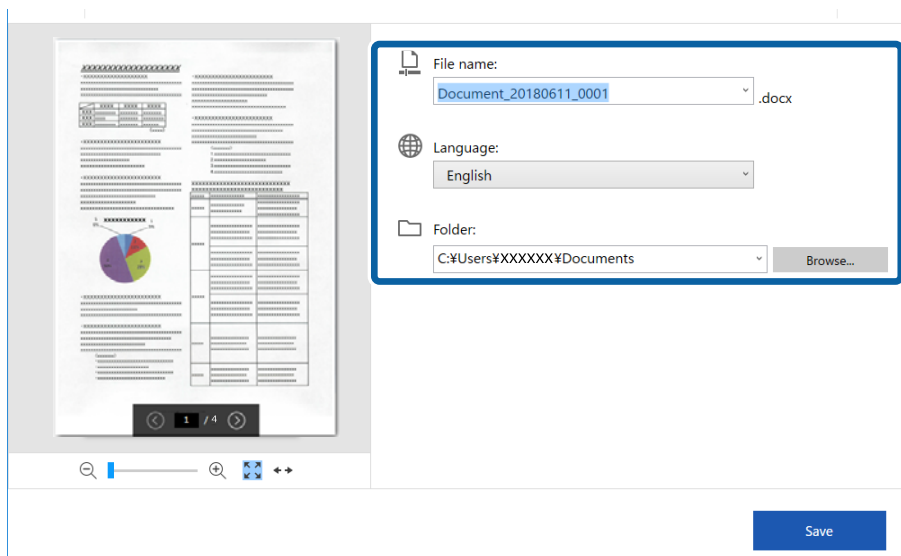

## Advanced Scanning

**Note:**

You can add OCR languages. Select **Other languages** from **Language**, and then select the languages you want to add from the list.

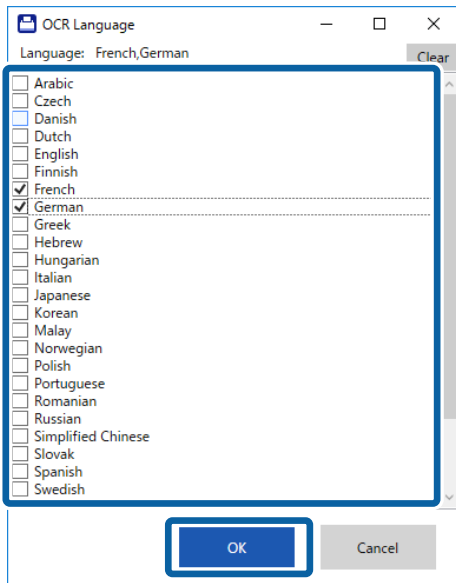

6. Click **Save** .

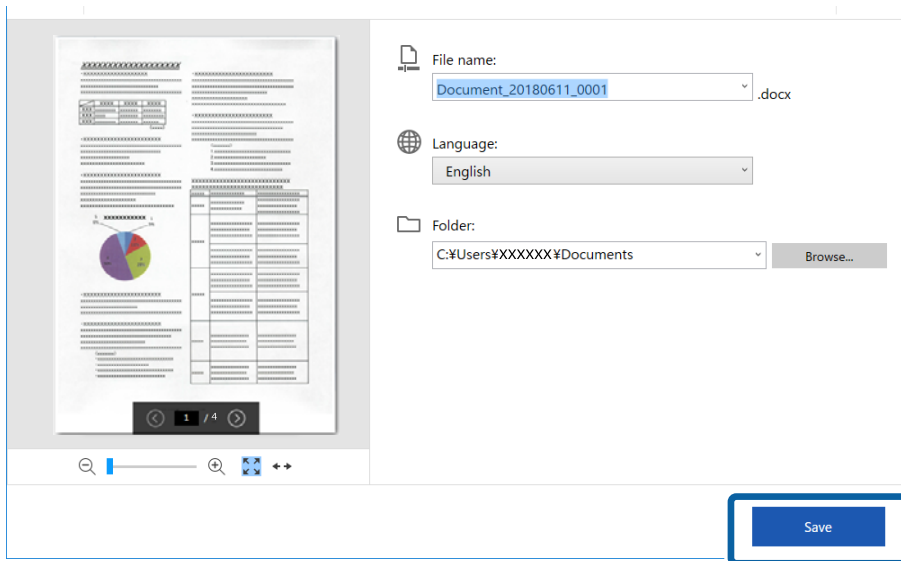

### Related Information

➔ [“Scanning and Saving Documents” on page 37](#)

---



## Sending to a Cloud Service

You can save to the following cloud services.

- Google Drive
- Dropbox

## Advanced Scanning

### ☐ Evernote

1. Place the originals on your scanner.
2. Press the  button on the scanner to start scanning and open Epson ScanSmart.
  - ☐ If you cannot start scanning from the  button on the scanner, see the link in Related Information at the end of the chapter.
  - ☐ You can also start scanning from your computer.  
Start Epson ScanSmart, and then click **SCAN**.
3. Check the scanned image and click **Next**.
4. Select where you want to send the data.

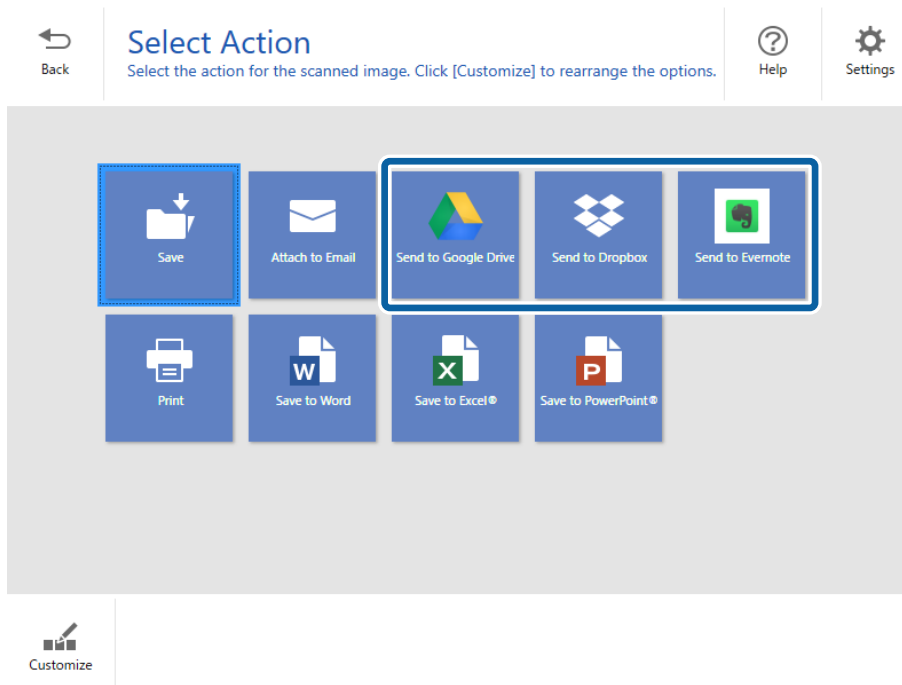

### Advanced Scanning

5. Click **Login** to login to your account.

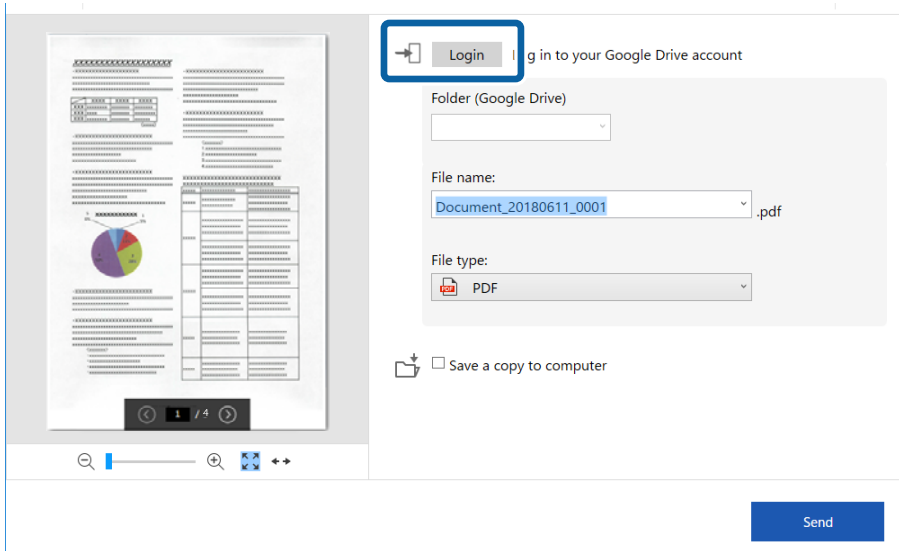

6. Check or change the settings as necessary.

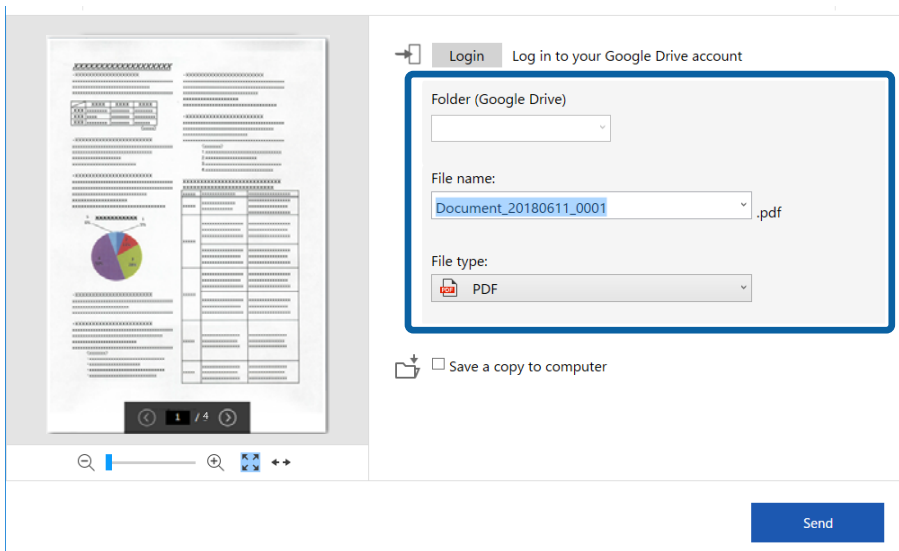

### Advanced Scanning

**Note:**

- ❑ When you select **Searchable PDF** as the **File type** setting, the **Language** list box is displayed. Select **Other languages** and then select the languages from the list on the **OCR Language** window.

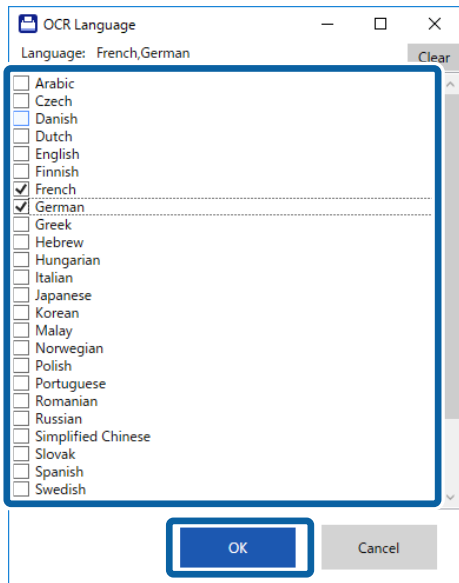

- ❑ Select **Save a copy to computer** if you want to save the data to your computer.

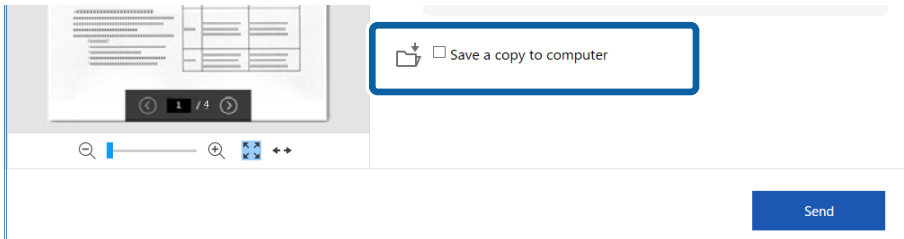

7. Click **Send**.

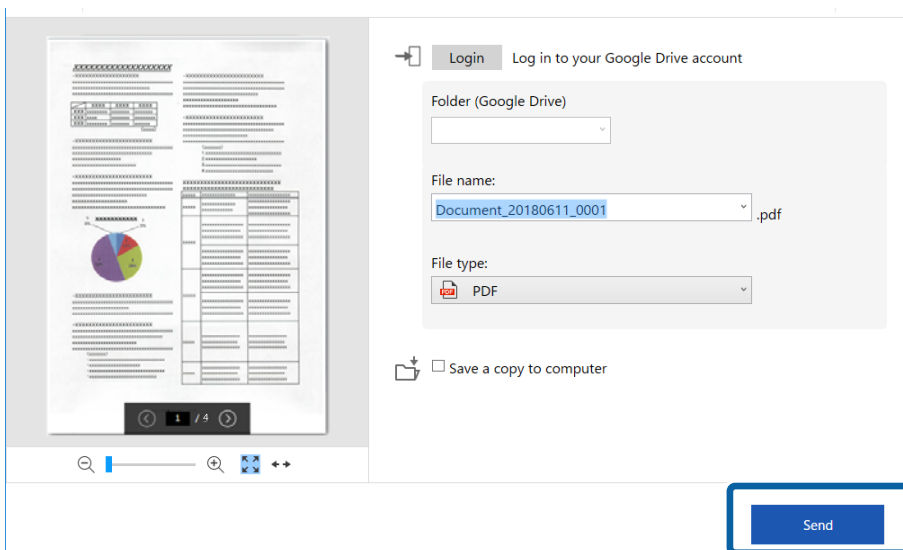

## Advanced Scanning

### Related Information

➔ [“Scanning and Saving Documents” on page 37](#)

# Maintenance

---

## Cleaning Outside the Scanner

Wipe off any stains on the outer case with a dry cloth or a cloth dampened with mild detergent and water.

**!** **Important:**

- Never use alcohol, thinner, or any corrosive solvent to clean the scanner. Deformation or discoloration may occur.
- Do not let water get inside the product. This could cause a malfunction to occur.
- Never open the scanner case.

1. Set the  switch to turn off the scanner.
2. Remove the USB cable.
3. Clean the outer case with a cloth dampened with mild detergent and water.  
Wipe the LCD panel by using a soft, dry cloth.

---

## Cleaning Inside the Scanner

After using the scanner for a while, paper and room dust on the roller or the glass part inside the scanner may cause paper feed or scanned image quality problems. If this occurs, clean the inside of the scanner using the Cleaning Sheet that is exclusively for your product.

**!** **Important:**

- Only use the Cleaning sheet supplied with your product, otherwise scanner components could be damaged.
- Never use alcohol, thinner, or any corrosive solvent to clean the scanner. Deformation or discoloration may occur.
- Never spray any liquid or lubricant on the scanner. Damage to equipment or circuits may cause abnormal operations.
- Never open the scanner case.

1. Make sure that the product is turned on.
2. Load the Cleaning sheet into the product.

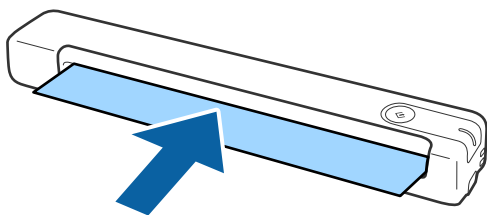

## Maintenance

### 3. Start Epson Scan 2 Utility.

#### Windows 10

Click the start button, and then select **All apps > EPSON > Epson Scan 2 > Epson Scan 2 Utility**.

#### Windows 8.1/Windows 8

**Start screen > Apps > Epson > Epson Scan 2 Utility**.

#### Windows 7

Click the start button, and then select **All Programs (or Programs) > EPSON > Epson Scan 2 > Epson Scan 2 Utility**.

#### Mac OS

Select **Go > Applications > EPSON Software > Epson Scan 2 Utility**.

### 4. Click the **Maintenance** tab.

### 5. Click the **Cleaning** button.

Cleaning starts. Wait about 30 seconds.

The Cleaning sheet is ejected automatically when cleaning is complete.

Try repeating this procedure if the scanner is not cleaned at the first attempt.

#### **Note:**

- If dirt still remains, try using the Cleaning sheet (wet) sold as a Maintenance Sheet in the Epson store. Remove the Cleaning sheet (wet) from its bag, unfold it, and then follow the same steps as when cleaning the product using the Cleaning sheet. The Cleaning sheet (wet) can only be used once. If you cannot clean the product using the Cleaning sheet (wet), contact your Epson dealer. Do not disassemble your product. The best before date for the Cleaning sheet (wet) is approximately three years from the production date printed on the package.*
- The Cleaning sheet, Cleaning sheet (wet), and Calibration sheet are available as a Maintenance Sheet from your nearest Epson store.*
- The Cleaning sheet can be used more than once. However, if it begins to lose its effect, purchase a new Cleaning sheet.*
- Cleaning does not start if the product's batteries are running low.*

#### **Related Information**

➔ [“Maintenance Sheet Codes” on page 15](#)

---

## Scanner Adjustment Using the Calibration Sheet

You can adjust the scanned image quality using the Calibration sheet supplied with your product.

Perform calibration in the following situations.

- The results are blurred
- The colors differ from the original
- The density differs from the original
- Vertical lines appear in the results

### 1. Make sure that the product is turned on.

## Maintenance

2. Load the Calibration sheet into the product.

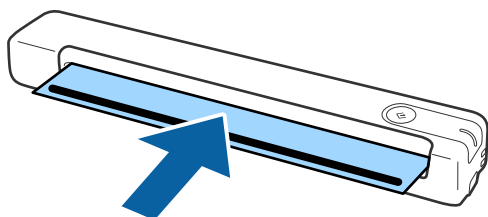

**Note:**

*Before loading the Calibration sheet into the scanner, make sure there is no dust or dirt on the Calibration sheet.*

3. Start Epson Scan 2 Utility.

- Windows 10

Click the start button, and then select **All apps > EPSON > Epson Scan 2 > Epson Scan 2 Utility**.

- Windows 8.1/Windows 8

**Start screen > Apps > Epson > Epson Scan 2 Utility.**

- Windows 7

Click the start button, and then select **All Programs (or Programs) > EPSON > Epson Scan 2 > Epson Scan 2 Utility**.

- Mac OS

Select **Go > Applications > EPSON Software > Epson Scan 2 Utility**.

4. Click the **Maintenance** tab.

5. Click the **Calibration** button.

Calibration starts. Wait about one minute.

The Calibration sheet is ejected automatically when calibration is complete.

**Note:**

- If performing calibration does not improve the image quality, contact your Epson dealer.*
- You can use the Calibration sheet more than once.*
- The Cleaning sheet and the Calibration sheet are available as a Maintenance Sheet from your nearest Epson store.*
- Calibration does not start if the product's batteries are running low.*

### Related Information

- ➔ [“Maintenance Sheet Codes” on page 15](#)

---

## Energy Saving

You can save energy by using the sleep mode or auto power off mode when no operations are performed by the scanner. You can set the time period before the scanner enters sleep mode and turns off automatically. Any increase will affect the product's energy efficiency. Consider the environment before making any changes.

## Maintenance

1. Start Epson Scan 2 Utility.
  - ❑ Windows 10  
Click the start button, and then select **EPSON > Epson Scan 2 > Epson Scan 2 Utility**.
  - ❑ Windows 8.1/Windows 8  
**Start screen > Apps > Epson > Epson Scan 2 Utility**.
  - ❑ Windows 7  
Click the start button, and then select **All Programs (or Programs) > EPSON > Epson Scan 2 > Epson Scan 2 Utility**.
  - ❑ Mac OS  
Select **Go > Applications > EPSON Software > Epson Scan 2 Utility**.
2. Click the **Power Save** tab.
3. Set the **Sleep Timer (minutes)** or **Power Off Timer (minutes)**, and then click **Set**.

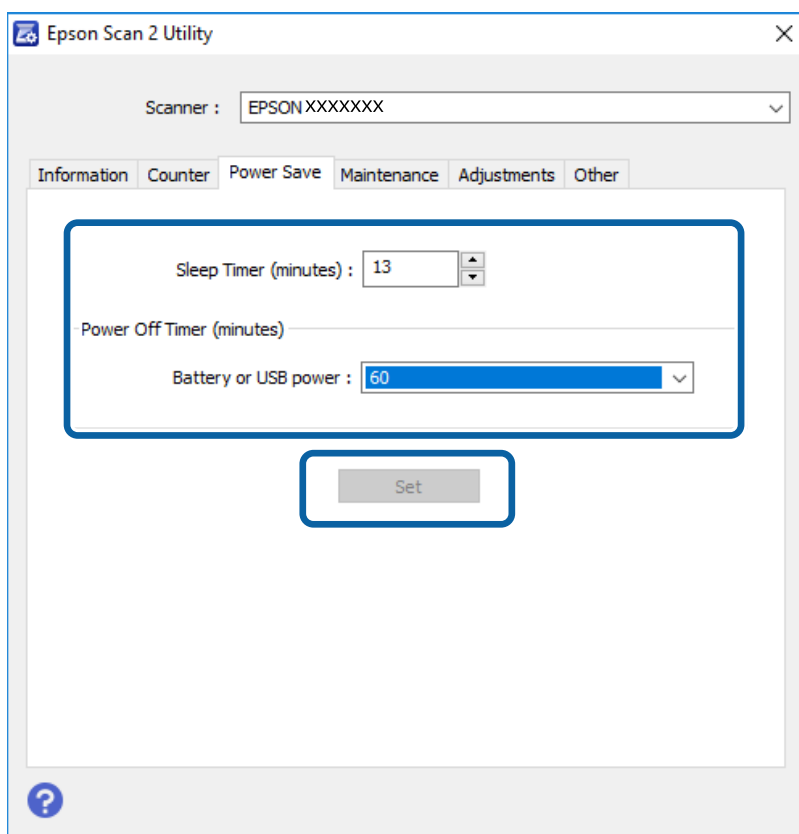

---

## Carrying the scanner

When you need to carry or transport the scanner to move it or to make repairs, follow the steps below to pack the scanner.

## Maintenance

### **Caution:**

- Strong impacts may damage the scanner.
- Do not expose the scanner to direct sunlight or leave it near heaters, in locations subject to high temperatures such as inside a car, and so on. The heat may cause the body to deform.
- We recommend taking the scanner as hand luggage on airplanes. Contact your airline to confirm if you can take the device on their airplanes. Depending on handling at the airport, the scanner could be damaged by a strong impact.

1. Set the  switch to turn off the scanner.
2. Remove the USB cable.
3. When transporting the scanner, attach the packing materials that came with the scanner, and then repack the scanner in its original box or a sturdy box.

---

## Updating Applications and Firmware

You may be able to clear certain problems and improve or add functions by updating the applications and the firmware. Make sure you use the latest version of the applications and firmware.

### **Important:**

- Make sure that the battery is fully charged or charging from the computer with a USB connection.
- Do not turn off the computer or the scanner while updating.

1. Make sure that the scanner and the computer are connected, and the computer is connected to the internet.
2. Start EPSON Software Updater, and update the applications or the firmware.
  - Windows 10  
Click the start button, and then select **Epson Software > EPSON Software Updater**.
  - Windows 8.1/Windows 8  
Enter the application name in the search charm, and then select the displayed icon.
  - Windows 7  
Click the start button, and then select **All Programs or Programs > Epson Software > EPSON Software Updater**.
  - Mac OS  
Select **Go > Applications > Epson Software > EPSON Software Updater**.

### **Note:**

If you cannot find the application you want to update in the list, you cannot update using the EPSON Software Updater. Check for the latest versions of the applications on your local Epson website.

<http://www.epson.com>

# Solving Problems

---

## Scanner Problems

### Scanner Lights Indicate an Error

Check the following if the scanner lights indicate an error.

- Make sure there are no originals jammed in the scanner.
- Make sure the scanner is connected to your computer properly.
  - If a Wi-Fi connection error has occurred, check the Wi-Fi connection settings.
- If the firmware update fails and the scanner enters recovery mode, update the firmware again using a USB connection.
- Turn off the scanner and turn it on again. If this does not solve the problem, the scanner may be malfunctioning, or the light source in the scanner unit may need to be replaced. Contact your dealer.

#### Related Information

- ➔ [“Buttons and Lights” on page 11](#)
- ➔ [“Error Indicators” on page 13](#)

### The Scanner Does Not Turn On

- Make sure the USB cable is securely connected to the scanner and the computer.
- Connect the scanner directly to the computer's USB port. The scanner may not work properly when connected to the computer through one or more USB hubs.
- Use the USB cable that came with the scanner.
- Wait a second after connecting the USB cable. It may take a few seconds until the scanner turns on.
- If the scanner is running on the battery under low or high temperatures, the scanner will not turn on. Use the scanner within the operating temperature range.

### The Scanner Turns Off when Running on the Battery

- Make sure the batteries have enough power.
- Use the scanner within the operating temperature range. The scanner may turn off suddenly under low or high temperatures.
- Make sure the Wi-Fi switch is on or connect to the computer using the USB cable. Otherwise, the scanner may turn off.

## Solving Problems

- Power Save** settings might be set in **Epson Scan 2 Utility**.

Start **Epson Scan 2 Utility**, click the **Power Save** tab, and then enter a longer value or set it to Off. To start **Epson Scan 2 Utility**, see following for details.

- Windows 10

Click the start button, and then select **All apps > EPSON > Epson Scan 2 Utility**.

- Windows 8.1/Windows 8

Enter the application name in the search charm, and then select the displayed icon.

- Windows 7

Click the start button, and then select **All Programs** or **Programs > EPSON > Epson Scan 2 > Epson Scan 2 Utility**.

- Mac OS

Select **Go > Applications > Epson Software > Epson Scan 2 Utility**.

## The Scanner Does not Turn Off when Running on the Battery

Make sure the USB cable is disconnected. Then press the reset button on the bottom of the scanner.

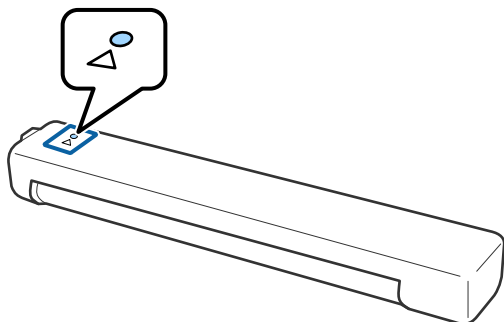

---

## Problems Starting Scanning

### Cannot Start Epson ScanSmart

Make sure the scanner is connected to your computer properly.

- Make sure the following applications are installed:

- Epson ScanSmart
- Epson Scan 2
- Epson Event Manager

If the applications are not installed, install them again.

## Solving Problems

**Note:**

See the following to check your applications.

**Windows 10:** Right-click the start button or press and hold it, and then select **Control Panel > Programs > Programs and Features**.

**Windows 8.1/Windows 8:** Select **Desktop > Settings > Control Panel > Programs > Programs and Features**.

**Windows 7:** Click the start button and select **Control Panel > Programs > Programs and Features**.

**Mac OS:** Select **Go > Applications > EPSON Software**.

Check the following when using the scanner over a network.

Check that the Wi-Fi connection is working correctly.

Try turning the wireless router's power off and then on again.

Make sure that you select the correct scanner.

Click  **Settings** in **Epson ScanSmart**, **Review Scans** or on the **Select Action** window, and then click the **Scan Settings** tab > **Change** to confirm or re-pair the scanner using your computer.

Make sure another computer is not connected by USB. A USB connection takes priority over a Wi-Fi connection. If another computer is connected by USB, disconnect it.

For Mac OS users:

Make sure you select the network that has priority on your Mac OS.

Check the following when using the scanner with a USB cable.

Make sure the USB cable is securely connected to the scanner and the computer.

Use the USB cable that came with the scanner.

Connect the scanner directly to the computer's USB port. The scanner may not work properly when connected to the computer through one or more USB hubs.

Make sure the scanner is turned on.

Wait until the status light stops flashing indicating that the scanner is ready to scan.

If you are using any TWAIN-compliant applications, make sure that the correct scanner is selected as the scanner or source setting.

**Related Information**

➔ [“Scanning Using a Scanner Button” on page 37](#)

➔ [“Installing Your Applications” on page 74](#)

---

## Removing Jammed Originals from the Scanner

If paper jams inside the scanner, slowly remove the jammed paper by gently pulling it in which ever direction offers the least resistance.

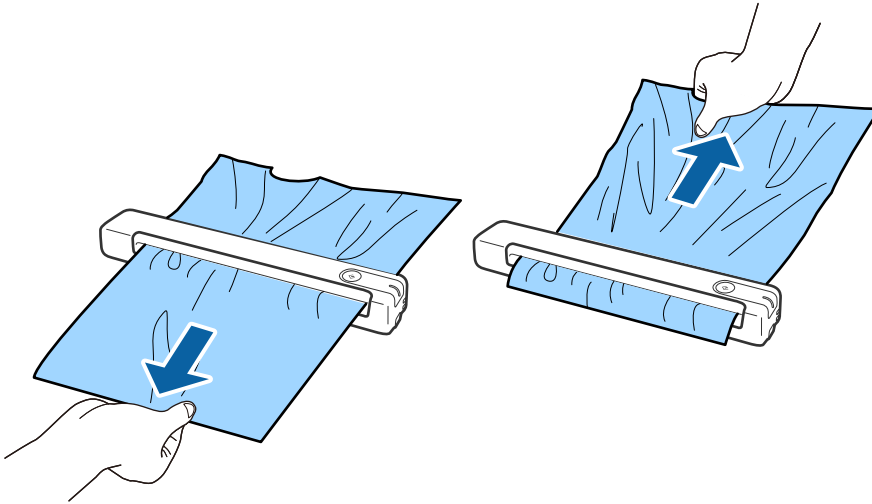
**Note:**

- If a piece of paper gets stuck in the roller and remains inside the scanner, remove it slowly with a pair of tweezers in the direction of the output slot. If you cannot remove it, contact your local dealer.
- Do not pull the jammed paper too forcefully, otherwise the document may be damaged slightly.

---

## The Originals Get Dirty

Clean the inside of the scanner.

**Related Information**

- ➔ [“Cleaning Inside the Scanner” on page 55](#)

---

## Scanning Takes a Long Time

- When the resolution is high, scanning may take some time.
- Computers with USB 2.0 (Hi-Speed) ports can scan faster than those with USB 1.1 ports. If you are using a USB 2.0 port with the scanner, make sure it meets the system requirements.
- When using security software, exclude the TWAIN.log file from monitoring, or set the TWAIN.log as a read-only file. For more information on your security software's functions, see the help and so on supplied with the software. The TWAIN.log file is saved in the following locations.
  - Windows 10/Windows 8.1/ Windows 8/ Windows 7:  
C:\Users\*(user name)*\AppData\Local\Temp
- Scanning may take some time depending on the strength of the Wi-Fi signal.

## Solving Problems

- When the battery is nearly empty, scanning may take some time. Charge the battery from a computer with a USB connection.

---

## Scanned Image Problems

### Streaks Appear in the Scanned Image

Streaks may appear in the image when trash or dirt gets into the scanner.

- Clean the inside of the scanner.
- Remove any trash or dirt that adheres to the original.
- Avoid operating the scanner in direct sunlight, otherwise streaks may appear in the image.

#### Related Information

➔ [“Cleaning Inside the Scanner” on page 55](#)

### Offset Appears in the Background of Images

Images on the back of the original may appear in the scanned image.

- When **Auto**, **Color**, or **Grayscale** is selected as the **Image Type**.
  - Check that **Remove Background** is selected.

Click  **Settings** in **Epson ScanSmart**, **Review Scans** or on the **Select Action** window, and then click the **Scanner Settings** tab > **Scan Settings** button > **Advanced Settings** tab on the Epson Scan 2 window > **Remove Background**.
  - Check that **Text Enhancement** is selected.

Click  **Settings** in **Epson ScanSmart**, **Review Scans** or on the **Select Action** window > **Scanner Settings** tab > **Scan Settings** button > **Advanced Settings** tab in Epson Scan 2 window > **Text Enhancement**.
- When **Black & White** is selected as the **Image Type**.
  - Check that **Text Enhancement** is selected.

Click  **Settings** in **Epson ScanSmart**, **Review Scans** or on the **Select Action** window, and then click the **Scanner Settings** tab > **Scan Settings** button > **Advanced Settings** tab on the Epson Scan 2 window > **Text Enhancement**.

Depending on the condition of your scanned image, click **Settings** and try setting a lower level for **Edge Enhancement** or a higher level for **Noise Reduction Level**.

### Scanned Image or Text is Blurred

You can adjust the appearance of the scanned image or text by increasing the resolution or adjusting the image quality.

## Solving Problems

- ❑ Try increasing the resolution and then scanning.

Set the appropriate resolution for the purpose of your scanned image.

Click  **Settings** in **Epson ScanSmart, Review Scans** or on the **Select Action** window, and then click the **Scanner Settings** tab > **Scan Settings** button > **Main Settings** tab on the Epson Scan 2 window > **Resolution**.

- ❑ Check that **Text Enhancement** is selected.

Click  **Settings** in **Epson ScanSmart, Review Scans** or on the **Select Action** window, and then click the **Scanner Settings** tab > **Scan Settings** button > **Advanced Settings** tab on the Epson Scan 2 window > **Text Enhancement**.

- ❑ When **Black & White** is selected as the **Image Type**.

Depending on the condition of your scanned image, click **Settings** and try setting a lower level for **Edge Enhancement** or a higher level for **Noise Reduction Level**.

- ❑ If you are scanning in JPEG format, try to change the compression level.

Click  **Settings** in **Epson ScanSmart, Review Scans** or on the **Select Action** window, and then click the **Save Settings** tab > **Options** button

## List of Recommended Resolutions to Suit Your Purpose

See the table and set the appropriate resolution for the purpose of your scanned image.

Purpose	Resolution (Reference)
Displaying on a screen Sending by email	Up to 200 dpi
Using Optical Character Recognition (OCR) Creating a text searchable PDF	200 to 300 dpi
Printing using a printer Sending by fax	200 to 300 dpi

## Moiré Patterns (Web-Like Shadows) Appear

If the original is a printed document, moiré patterns (web-like shadows) may appear in the scanned image.

- ❑ Check that **Descreening** is selected.

Click  **Settings** in **Epson ScanSmart, Review Scans** or on the **Select Action** window, and then click the **Scanner Settings** tab > **Scan Settings** button > **Advanced Settings** tab on the Epson Scan 2 window > **Descreening**.



## Solving Problems

- Change the resolution, and then scan again.

Click  **Settings** in **Epson ScanSmart**, **Review Scans** or on the **Select Action** window, and then click the **Scanner Settings** tab > **Scan Settings** button > **Main Settings** tab on the Epson Scan 2 window > **Resolution**.

### Related Information

- ➔ [“List of Recommended Resolutions to Suit Your Purpose” on page 65](#)

## The Edge of the Original is Not Scanned when Automatically Detecting the Size of the Original

Depending on the original, the edge of the original may not be scanned when automatically detecting the size of the original.

- Click  **Settings** in **Epson ScanSmart**, **Review Scans** or on the **Select Action** window, and then click the **Scanner Settings** tab > **Scan Settings** button.

In Epson Scan 2, select the **Main Settings** tab, and then select **Document Size** > **Settings**. On the **Document Size Settings** window, adjust **Crop Margins for Size** "Auto".

- Depending on the original, the area of the original may not be detected correctly when using the **Auto Detect** feature. Select the appropriate size of the original from the **Document Size** list.

Click  **Settings** in **Epson ScanSmart**, **Review Scans** or on the **Select Action** window, and then click the **Scanner Settings** tab > **Scan Settings** button.

In Epson Scan 2, click the **Main Settings** tab, and then click **Document Size**.

### Note:

*If the size of the original you want to scan is not on the list, select **Customize**, and then create the size manually.*

Click  **Settings** in **Epson ScanSmart**, **Review Scans** or on the **Select Action** window, and then click the **Scanner Settings** tab > **Scan Settings** button.

*In Epson Scan 2, click the **Main Settings** tab, and then click **Customize** in **Document Size**.*

## Character is not Recognized Correctly

Check the following to increase the recognition rate of OCR (Optical Character Recognition).

- Check that the original is placed straight.
- Use an original with clear text. Text recognition may decline for the following types of originals.
  - Originals that have been copied several times
  - Originals received by fax (at low resolutions)
  - Originals where the letter spacing or line spacing is too small
  - Originals with ruled lines or underlining over the text
  - Originals with hand written text
  - Originals with creases or wrinkles
- Paper type made of thermal paper such as receipts may deteriorate due to age or friction. Scan them as soon as possible.

## Solving Problems

- ❑ When saving to Microsoft® Office or **Searchable PDF** files, check that the correct languages are selected.  
Check the **Language** in each save setting window.

### Related Information

- ➔ [“Scanned Image or Text is Blurred” on page 64](#)
- ➔ [“Saving as Editable Files \(Microsoft® Office\)” on page 48](#)

## Expanding or Contracting the Scanned Image

When expanding or contracting the scanned image, you can adjust the expansion ratio by using the **Adjustments** feature in Epson Scan 2 Utility. This feature is only available for Windows.

### Note:

*Epson Scan 2 Utility is one of the applications supplied with the scanner software.*

1. Start Epson Scan 2 Utility.
  - ❑ Windows 10  
Click the start button, and then select **EPSON > Epson Scan 2 > Epson Scan 2 Utility**.
  - ❑ Windows 8.1/Windows 8  
Enter the application name in the search charm, and then select the displayed icon.
  - ❑ Windows 7  
Click the start button, and then select **All Programs or Programs > EPSON > Epson Scan 2 > Epson Scan 2 Utility**.
2. Select the **Adjustments** tab.
3. Use **Expansion/Contraction** to adjust the expansion ratio for scanned images.
4. Click **Set** to apply the settings to the scanner.

## The Scanned Image of the Plastic Card is Enlarged

Change the orientation of the card and then scan it again. If it still does not improve, remove any dirt on the card and use the Cleaning sheet to clean inside the scanner.

### Related Information

- ➔ [“Cleaning Inside the Scanner” on page 55](#)

## Cannot Solve Problems in the Scanned Image

If you have tried all of the solutions and have not solved the problem, initialize the application settings by using Epson Scan 2 Utility.

### Note:

*Epson Scan 2 Utility is one of the applications supplied with the scanner software.*

## Solving Problems

1. Start Epson Scan 2 Utility.

Windows 10

Click the start button, and then select **EPSON > Epson Scan 2 Utility**.

Windows 8.1/Windows 8

Enter the application name in the search charm, and then select the displayed icon.

Windows 7

Click the start button, and then select **All Programs** or **Programs > EPSON > Epson Scan 2 > Epson Scan 2 Utility**.

Mac OS

Select **Go > Applications > Epson Software > Epson Scan 2 Utility**.

2. Select the **Other** tab.

3. Click **Reset**.

**Note:**

*If initialization does not solve the problem, uninstall and re-install Epson Scan 2.*

---

## Network Problems

### When You Cannot Make Network Settings

Turn off the devices you want to connect to the network. Wait for about 10 seconds, and then turn on the devices in the following order; access point, computer or smart device, and then scanner. Move the scanner and computer or smart device closer to the access point to help with radio wave communication, and then try to make network settings again.

### Cannot Connect from Devices Even Though Network Settings are No Problems

If you cannot connect from the computer or smart device to the scanner even though network settings of the scanner are no problem, see the following.

### Solving Problems

- ❑ When you are using multiple wireless routers at the same time, you may not be able to use the scanner from the computer or smart device depending on the settings of the wireless routers. Connect the computer or smart device to the same wireless router as the scanner.

Disable the tethering function on the smart device if it is enabled.

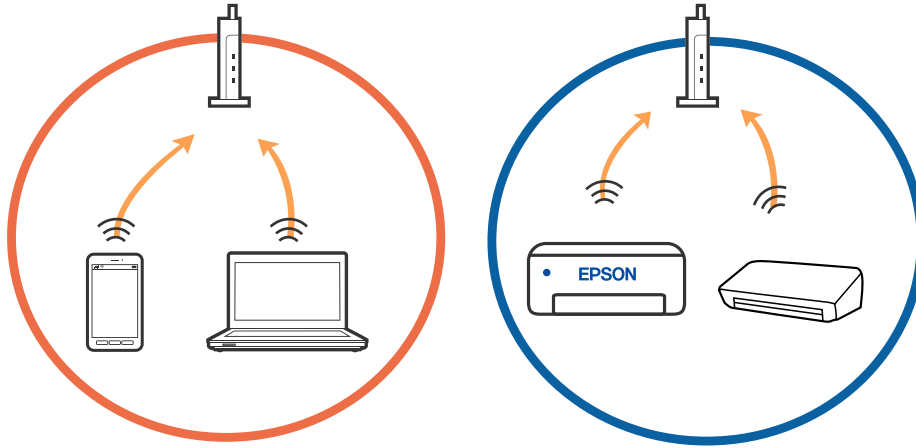

- ❑ You may not be able to connect to the wireless router when the wireless router has multiple SSIDs and devices are connected to different SSIDs on the same wireless router. Connect the computer or smart device to the same SSID as the scanner.

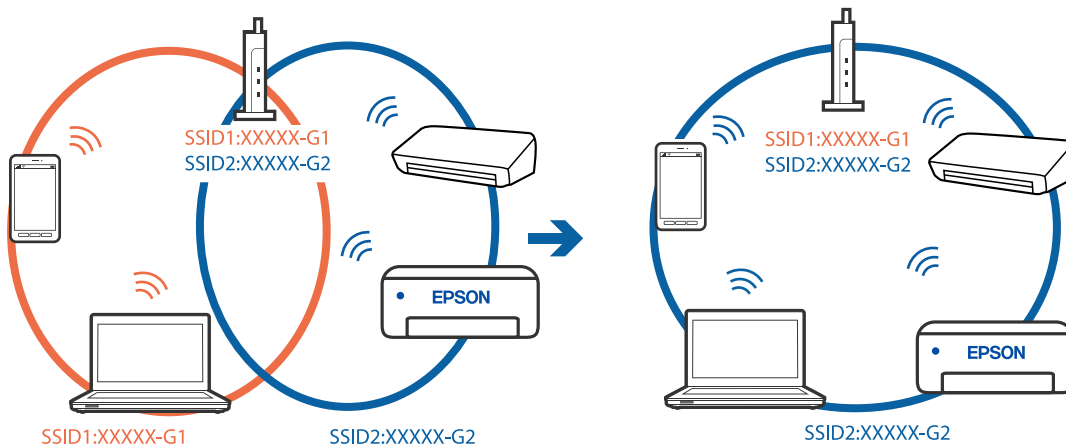

## Solving Problems

- ❑ A wireless router that is compliant with both IEEE802.11a and IEEE802.11g has SSIDs of 2.4 GHz and 5 GHz. If you connect the computer or smart device to a 5 GHz SSID, you cannot connect to the scanner because the scanner only supports communication over 2.4 GHz. Connect the computer or smart device to the same SSID as the scanner.

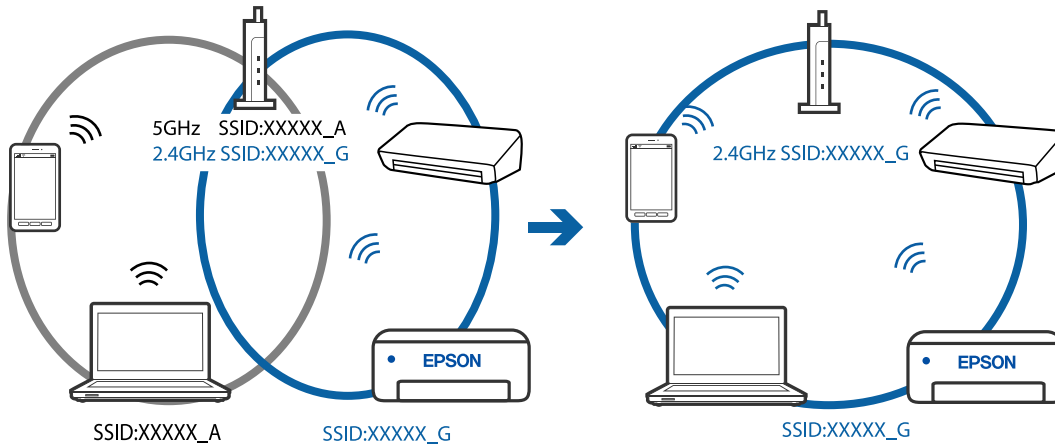

- ❑ Most wireless routers have a privacy separator feature that blocks communication between connected devices. If you cannot communicate between the scanner and the computer or smart device even if they are connected to the same network, disable the privacy separator on the wireless router. See the manual provided with the wireless router for details.

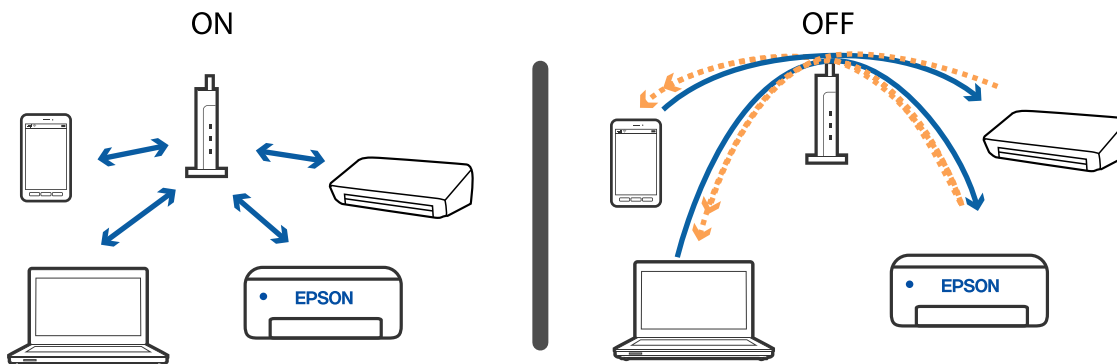

### Related Information

- ➔ [“Checking the SSID Connected to the Scanner” on page 70](#)
- ➔ [“Checking the SSID for the Computer” on page 71](#)

## Checking the SSID Connected to the Scanner

You can check the connected SSID on EpsonNet Config.

And you can check the SSID and password of scanner itself on the label stuck to the bottom face of the scanner. These are used when you connect the scanner in AP mode connection.

### Related Information

- ➔ [“EpsonNet Config” on page 14](#)

## Checking the SSID for the Computer

### Windows

Select **Control Panel > Network and Internet > Network and Sharing Center**.



### Mac OS

Click the Wi-Fi icon at the top of the computer screen. A list of SSIDs is displayed and the connected SSID is indicated with a check mark.



### Related Information

- ➔ [“Checking the SSID Connected to the Scanner” on page 70](#)
- ➔ [“Checking the SSID for the Computer” on page 71](#)

---

## The Scanner Suddenly Cannot Scan over a Network Connection

- ❑ When you have changed your access point or provider, try making network settings for the scanner again. Connect the computer or smart device to the same SSID as the scanner.
- ❑ Turn off the devices you want to connect to the network. Wait for about 10 seconds, and then turn on the devices in the following order; access point, computer or smart device, and then scanner. Move the scanner and computer or smart device closer to the access point to help with radio wave communication, and then try to make network settings again.
- ❑ Try accessing any website from your computer to make sure that your computer's network settings are correct. If you cannot access any websites, there is a problem on the computer. See the manual provided with your computer for more details.

### Related Information

- ➔ [“Changing the Connection Method to a Computer” on page 23](#)

---

## The Scanner Suddenly Cannot Scan Using a USB Connection

- ❑ Disconnect the USB cable from the computer. Right-click on the scanner icon displayed on the computer, and then select **Remove Device**. Connect the USB cable to the computer and try a test scan. If scanning is possible, the setup is complete.
- ❑ Re-set the USB connection following the steps in [Changing the Connection Method to a Computer] in this manual.
- ❑ If a computer is connected to the scanner by USB while another computer is also connected to the scanner over a wireless connection and Epson Scan 2 is running on this computer, scanned images are saved to the wirelessly connected scanner when you press the scanner button. Scan from the computer instead of using the scanner button or close Epson Scan 2 on the wirelessly connected computer.

### Related Information

- ➔ [“Changing the Connection Method to a Computer” on page 23](#)

---

## Uninstalling and Installing Applications

### Uninstalling Your Applications

You may need to uninstall and then reinstall your applications to solve certain problems or if you upgrade your operating system. Log on to your computer as an administrator. Enter the administrator password if the computer prompts you.

## Uninstalling Your Applications for Windows

1. Quit all running applications.
2. Disconnect the scanner from your computer.
3. Open the Control Panel:
  - Windows 10  
Right-click the start button or press and hold it, and then select **Control Panel**.
  - Windows 8.1/Windows 8  
Select **Desktop > Settings > Control Panel**.
  - Windows 7  
Click the start button and select **Control Panel**.
4. Open **Uninstall a program** (or **Add or Remove Programs**):
  - Windows 10/Windows 8.1/Windows 8/Windows 7  
Select **Uninstall a program** in **Programs**.
  - Click **Add or Remove Programs**.
5. Select the application you want to uninstall.
6. Uninstall the applications:
  - Windows 10/Windows 8.1/Windows 8/Windows 7  
Click **Uninstall/Change** or **Uninstall**.
  - Click **Change/Remove** or **Remove**.

**Note:**  
*If the User Account Control window is displayed, click Continue.*
7. Follow the on-screen instructions.

**Note:**  
*A message may be displayed prompting you to restart your computer. If it is displayed, make sure **I want to restart my computer now** is selected, and then click **Finish**.*

## Uninstalling Your Applications for Mac OS

**Note:**  
*Make sure you installed EPSON Software Updater.*

1. Download the Uninstaller using EPSON Software Updater.  
Once you have downloaded the Uninstaller, you do not need to download it again each time you uninstall the application.
2. Disconnect the scanner from your computer.
3. To uninstall the scanner driver, select **System Preferences** from the  menu > **Printers & Scanners** (or **Print & Scan, Print & Fax**), and then remove the scanner from the enabled scanner list.

## Solving Problems

4. Quit all running applications.
5. Select **Go > Applications > Epson Software > Uninstaller**.
6. Select the application you want to uninstall, and then click Uninstall.

**Important:**

*The Uninstaller removes all drivers for Epson scanners on the computer. If you use multiple Epson scanners and you only want to delete some of the drivers, delete all of them first, and then install the necessary scanner drivers again.*

**Note:**

*If you cannot find the application you want to uninstall in the application list, you cannot uninstall using the Uninstaller. In this situation, select **Go > Applications > Epson Software**, select the application you want to uninstall, and then drag it to the trash icon.*

## Installing Your Applications

Follow the steps below to install the necessary applications.

**Note:**

- Log on to your computer as an administrator. Enter the administrator password if the computer prompts you.
- When reinstalling applications, you need to uninstall them first.

1. Quit all running applications.
2. When installing Epson ScanSmart, disconnect the scanner and the computer temporarily.

**Note:**

*Do not connect the scanner and the computer until you are instructed to do so.*

3. Install the application by following the instructions on the Website below.

<http://epson.sn>

**Note:**

*For Windows, you can also use the software disc that came with the scanner.*

# Technical Specifications

## General Scanner Specifications

**Note:**

Specifications are subject to change without notice.

Scanner type	Portable sheet-feed, simplex A4 color scanner
Photoelectric device	CIS
Effective pixels	5,100×8,400 at 600 dpi 2,550×21,600 at 300 dpi (long paper)
Light source	RGB LED
Scanning resolution	600 dpi (main scan) 600 dpi (sub scan)
Output resolution	50 to 1,200 dpi (in 1 dpi increments)*1
Document Size	Max: 216×1,828.8 mm (8.5×72 in.) Min: 50.8×50.8 mm (2×2 in.)
Paper input	Face-up loading
Paper output	Face-up ejection
Paper capacity	1 sheet (80g/m2)
Color Depth	<p>Color</p> <ul style="list-style-type: none"> <li><input type="checkbox"/> 48 bits per pixel internal (16 bits per pixel per color internal)</li> <li><input type="checkbox"/> 24 bits per pixel external (8 bits per pixel per color external)</li> </ul> <p>Grayscale</p> <ul style="list-style-type: none"> <li><input type="checkbox"/> 16 bits per pixel internal</li> <li><input type="checkbox"/> 8 bits per pixel external</li> </ul> <p>Black and white</p> <ul style="list-style-type: none"> <li><input type="checkbox"/> 16 bits per pixel internal</li> <li><input type="checkbox"/> 1 bit per pixel external</li> </ul>
Interface*2	USB 2.0 (Hi-speed USB) IEEE802.11b/g/n

\*1 50 to 300 dpi (355.6 to 1,828.8 mm (14 to 72 in.) in length)

\*2 You cannot use a USB and network connection at the same time.

## Technical Specifications

### Wi-Fi Specifications

Standards	IEEE802.11b/g/n
Frequency Range	2.4 GHz
Maximum radio-frequency power transmitted	20 dBm (EIRP)
Coordination Modes	Infrastructure mode, AP mode <sup>*1 *2</sup>
Wireless Security	WEP (64/128bit), WPA2-PSK (AES) <sup>*1 *3</sup>

\*1 Not supported for IEEE 802.11b.

\*2 AP mode connection and Wi-Fi connection can be used at the same time.

\*3 Complies with WPA2 standards with support for WPA/WPA2 Personal.

### Dimensional Specifications

Dimensions	Width: 272 mm (10.7 in.) Depth: 47 mm (1.9 in.) Height: 34.3 mm (1.4 in.)*
Weight	Approx. 0.3 kg (0.7 lb)

\* Without protruding parts.

### Electrical Specifications

#### Scanner Electrical Specifications

Rated DC Input Power Supply Voltage	DC 5 V
Rated DC Input Current	0.5 A

### Technical Specifications

Power Consumption *	<p>USB Connection</p> <ul style="list-style-type: none"> <li><input type="checkbox"/> Operating: Approx. 2.7 W</li> <li><input type="checkbox"/> Ready mode: Approx. 1.6 W</li> <li><input type="checkbox"/> Sleep mode: Approx. 1 W</li> <li><input type="checkbox"/> Power off: 0.2 W or below</li> </ul> <p>Wi-Fi Connection</p> <ul style="list-style-type: none"> <li><input type="checkbox"/> Operating: Approx. 3.1 W</li> <li><input type="checkbox"/> Ready mode: Approx. 2.4 W</li> <li><input type="checkbox"/> Sleep mode: Approx. 1.9 W</li> <li><input type="checkbox"/> Power off: 0.2 W or below</li> </ul>
---------------------	---

\* When the battery is fully charged.

### Battery Specifications

Type	Li-ion
Rated Voltage	3.6 V
Rated Capacity	1140mAh
Charging Time	USB 2.0 Port: Approx. 3.5 hours*

\* These values are measured under the condition that the scanner is turned off. If the scanner is on, charging takes longer.

### Environmental Specifications

Temperature	When operating	5 to 35 °C (41 to 95 °F)
	When charging	8 to 35 °C (47 to 95 °F)
	When stored	-25 to 60 °C (-13 to 140 °F)
Humidity	When operating	10 to 85% (without condensation)
	When stored	10 to 90% (without condensation)
Operating conditions		Avoid operating the scanner in direct sunlight, near a strong light source, or in extremely dusty conditions.

---

## System Requirements

Windows	Windows 10 (32-bit, 64-bit) Windows 8.1 (32-bit, 64-bit) Windows 8 (32-bit, 64-bit) Windows 7 (32-bit, 64-bit)
Mac OS*1 *2	macOS High Sierra macOS Sierra OS X El Capitan

\*1 Fast User Switching on Mac OS or later is not supported.

\*2 The UNIX File System (UFS) for Mac OS is not supported.

# Standards and Approvals

---

## Standards and Approvals for U.S. Model

Safety	UL60950-1 CAN/CSA-C22.2 No. 60950-1
EMC	FCC Part 15 Subpart B Class B ICIS-033 Class B

This equipment contains the following wireless module.

Model: WM294V2-E01

This product conforms to Part 15 of the FCC Rules and RSS-210 of the IC Rules. Epson cannot accept responsibility for any failure to satisfy the protection requirements resulting from a non-recommended modification of the product. Operation is subject to the following two conditions: (1) this device may not cause harmful interference, and (2) this device must accept any interference received, including interference that may cause undesired operation of the device.

To prevent radio interference to the licensed service, this device is intended to be operated indoors and away from windows to provide maximum shielding. Equipment (or its transmit antenna) that is installed outdoors is subject to licensing.

---

## Standards and Approvals for European Model

For European users

Hereby, Seiko Epson Corporation declares that the following radio equipment model is in compliance with Directive 2014/53/EU. The full text of the EU declaration of conformity is available at the following website.

<http://www.epson.eu/conformity>

J421A

For use only in Ireland, UK, Austria, Germany, Liechtenstein, Switzerland, France, Belgium, Luxemburg, Netherlands, Italy, Portugal, Spain, Denmark, Finland, Norway, Sweden, Iceland, Croatia, Cyprus, Greece, Slovenia, Malta, Bulgaria, Czech, Estonia, Hungary, Latvia, Lithuania, Poland, Romania, and Slovakia.

Epson cannot accept responsibility for any failure to satisfy the protection requirements resulting from a non-recommended modification of the products.

To comply with RF exposure compliance requirements, a distance of at least 20 cm must be maintained at all times between this unit and people in the vicinity.



---

## Standards and Approvals for Australian Models

EMC	AS/NZS CISPR32 Class B
-----	------------------------

Epson hereby declares that the following equipment Models are in compliance with the essential requirements and other relevant provisions of AS/NZS4268:

J421A

Epson cannot accept responsibility for any failure to satisfy the protection requirements resulting from a non-recommended modification of the product.

# Where to Get Help

---

## Technical Support Web Site

If you need further help, visit the Epson support website shown below. Select your country or region and go to the support section of your local Epson website. The latest drivers, FAQs, manuals, or other downloadables are also available from the site.

<http://support.epson.net/>

<http://www.epson.eu/Support> (Europe)

If your Epson product is not operating properly and you cannot solve the problem, contact Epson support services for assistance.

---

## Contacting Epson Support

### Before Contacting Epson

If your Epson product is not operating properly and you cannot solve the problem using the troubleshooting information in your product manuals, contact Epson support services for assistance. If Epson support for your area is not listed below, contact the dealer where you purchased your product.

Epson support will be able to help you much more quickly if you give them the following information:

- Product serial number  
(The serial number label is usually on the back of the product.)
- Product model
- Product software version  
(Click **About**, **Version Info**, or a similar button in the product software.)
- Brand and model of your computer
- Your computer operating system name and version
- Names and versions of the software applications you normally use with your product

**Note:**

*Depending on the product, the dial list data for fax and/or network settings may be stored in the product's memory. Due to breakdown or repair of a product, data and/or settings may be lost. Epson shall not be responsible for the loss of any data, for backing up or recovering data and/or settings even during a warranty period. We recommend that you make your own backup data or take notes.*

### Help for Users in Europe

Check your Pan-European Warranty Document for information on how to contact Epson support.

## Where to Get Help

### Help for Users in Taiwan

Contacts for information, support, and services are:

#### World Wide Web

<http://www.epson.com.tw>

Information on product specifications, drivers for download, and products enquiry are available.

#### Epson HelpDesk

Phone: +886-2-80242008

Our HelpDesk team can help you with the following over the phone:

- Sales enquiries and product information
- Product usage questions or problems
- Enquiries on repair service and warranty

#### Repair service center:

<http://www.tekcare.com.tw/branchMap.page>

TekCare corporation is an authorized service center for Epson Taiwan Technology & Trading Ltd.

### Help for Users in Australia

Epson Australia wishes to provide you with a high level of customer service. In addition to your product manuals, we provide the following sources for obtaining information:

#### Internet URL

<http://www.epson.com.au>

Access the Epson Australia World Wide Web pages. Worth taking your modem here for the occasional surf! The site provides a download area for drivers, Epson contact points, new product information and technical support (e-mail).

#### Epson Helpdesk

Phone: 1300-361-054

Epson Helpdesk is provided as a final backup to make sure our clients have access to advice. Operators on the Helpdesk can aid you in installing, configuring and operating your Epson product. Our Pre-sales Helpdesk staff can provide literature on new Epson products and advise where the nearest dealer or service agent is located. Many types of queries are answered here.

We encourage you to have all the relevant information on hand when you ring. The more information you prepare, the faster we can help solve the problem. This information includes your Epson product manuals, type of computer, operating system, application programs, and any information you feel is required.

#### Transportation of Product

Epson recommends retaining product packaging for future transportation.

## Where to Get Help

### Help for Users in Singapore

Sources of information, support, and services available from Epson Singapore are:

#### World Wide Web

<http://www.epson.com.sg>

Information on product specifications, drivers for download, Frequently Asked Questions (FAQ), Sales Enquiries, and Technical Support via e-mail are available.

#### Epson HelpDesk

Toll Free: 800-120-5564

Our HelpDesk team can help you with the following over the phone:

- Sales enquiries and product information
- Product usage questions or problem troubleshooting
- Enquiries on repair service and warranty

### Help for Users in Thailand

Contacts for information, support, and services are:

#### World Wide Web

<http://www.epson.co.th>

Information on product specifications, drivers for download, Frequently Asked Questions (FAQ), and e-mail are available.

#### Epson Call Centre

Phone: 66-2685-9899

Email: [support@eth.epson.co.th](mailto:support@eth.epson.co.th)

Our Call Centre team can help you with the following over the phone:

- Sales enquiries and product information
- Product usage questions or problems
- Enquiries on repair service and warranty

### Help for Users in Vietnam

Contacts for information, support, and services are:

#### Epson Service Center

65 Truong Dinh Street, District 1, Hochiminh City, Vietnam.

Phone(Ho Chi Minh City): 84-8-3823-9239, 84-8-3825-6234

29 Tue Tinh, Quan Hai Ba Trung, Hanoi City, Vietnam

## Where to Get Help

Phone(Hanoi City): 84-4-3978-4785, 84-4-3978-4775

## Help for Users in Indonesia

Contacts for information, support, and services are:

### World Wide Web

<http://www.epson.co.id>

- Information on product specifications, drivers for download
- Frequently Asked Questions (FAQ), Sales Enquiries, questions through e-mail

### Epson Hotline

Phone: +62-1500-766

Fax: +62-21-808-66-799

Our Hotline team can help you with the following over the phone or fax:

- Sales enquiries and product information
- Technical support

### Epson Service Center

Province	Company Name	Address	Phone E-mail
DKI JAKARTA	ESS JAKARTA MANGGADUA	Ruko Mall Mangga Dua No. 48 Jl. Arteri Mangga Dua, Jakarta Utara - DKI JAKARTA	(+6221) 62301104 jkt-admin@epson-indonesia.co.id
NORTH SUMATERA	ESC MEDAN	Jl. Bambu 2 Komplek Graha Niaga Nomor A-4, Medan - North Sumatera	(+6261) 42066090 / 42066091 mdn-adm@epson-indonesia.co.id
WEST JAWA	ESC BANDUNG	Jl. Cihampelas No. 48 A Bandung Jawa Barat 40116	(+6222) 4207033 bdg-admin@epson- indonesia.co.id
DI YOGYAKARTA	ESC YOGYAKARTA	YAP Square, Block A No. 6 Jl. C Simanjutak Yogyakarta - DIY	(+62274) 581065 ygy-admin@epson-indonesia.co.id
EAST JAWA	ESC SURABAYA	Hitech Mall Lt. 2 Block A No. 24 Jl. Kusuma Bangsa No. 116 - 118 Surabaya - JATIM	(+6231) 5355035 sby-admin@epson-indonesia.co.id
SOUTH SULAWESI	ESC MAKASSAR	Jl. Cendrawasih NO. 3A, kunjung mae, mariso, MAKASSAR - SULSEL 90125	(+62411) 8911071 mksr-admin@epson- indonesia.co.id
WEST KALIMANTAN	ESC PONTIANAK	Komp. A yani Sentra Bisnis G33, Jl. Ahmad Yani - Pontianak Kalimantan Barat	(+62561) 735507 / 767049 pontianak-admin@epson- indonesia.co.id

## Where to Get Help

Province	Company Name	Address	Phone E-mail
RIAU	ESC PEKANBARU	Jl. Tuanku Tambusai No.459A Pekanbaru Riau	(+62761) 8524695 pkb-admin@epson-indonesia.co.id
DKI JAKARTA	ESS JAKARTA SUDIRMAN	Wisma Keiai Lt. 1 Jl. Jenderal Sudirman Kav. 3 Jakarta Pusat - DKI JAKARTA 10220	(+6221) 5724335 ess@epson-indonesia.co.id
EAST JAVA	ESS SURABAYA	Ruko Surya Inti Jl. Jawa No 2-4 Kav. 29 Surabaya - Jawa Timur	(+6231) 5014949 esssby@epson-indonesia.co.id
BANTEN	ESS SERPONG	Ruko Mall WTC Matahari No. 953, Serpong-Banten	(+6221) 53167051 / 53167052 esstag@epson-indonesia.co.id
CENTRAL JAWA	ESS SEMARANG	Komplek Ruko Metro Plaza Block C20 Jl. MT Haryono No 970 Semarang - JAWA TENGAH	(+6224) 8313807 / 8417935 esssmg@epson-indonesia.co.id
EAST KALIMANTAN	ESC SAMARINDA	Jl. KH. Wahid Hasyim (M. Yamin) Kelurahan Sempaja Selatan Kecamatan Samarinda UTARA - SAMARINDA - KALTIM	(+62541) 7272904 escsmd@epson-indonesia.co.id
SOUTH SUMATERA	ESC PALEMBANG	Jl. H.M Rasyid Nawawi No. 249 Kelurahan 9 Ilir Palembang Sumatera Selatan	(+62711) 311330 escplg@epson-indonesia.co.id
EAST JAVA	ESC JEMBER	JL. Panglima Besar Sudirman Ruko no.1D Jember-Jawa Timur (Depan Balai Penelitian & Pengolahan Kakao)	(+62331) 488373 / 486468 jmr-admin@epson-indonesia.co.id
NORTH SULAWESI	ESC MANADO	Tekno Megamall Lt LG 11 TK 21, Kawasan Megamas Boulevard, Jl Piere Tendean, Manado - SULUT 95111	(+62431) 8890996 MND-ADMIN@EPSON-INDONESIA.CO.ID

For other cities not listed here, call the Hot Line: 08071137766.

## Help for Users in Hong Kong

To obtain technical support as well as other after-sales services, users are welcome to contact Epson Hong Kong Limited.

### Internet Home Page

<http://www.epson.com.hk>

Epson Hong Kong has established a local home page in both Chinese and English on the Internet to provide users with the following information:

- Product information
- Answers to Frequently Asked Questions (FAQs)
- Latest versions of Epson product drivers

## Where to Get Help

### Technical Support Hotline

You can also contact our technical staff at the following telephone and fax numbers:

Phone: 852-2827-8911

Fax: 852-2827-4383

## Help for Users in Malaysia

Contacts for information, support, and services are:

### World Wide Web

<http://www.epson.com.my>

- Information on product specifications, drivers for download
- Frequently Asked Questions (FAQ), Sales Enquiries, questions through e-mail

### Epson Call Centre

Phone: +60 1800-8-17349

- Sales enquiries and product information
- Product usage questions or problems
- Enquiries on repair services and warranty

### Head Office

Phone: 603-56288288

Fax: 603-5628 8388/603-5621 2088

## Help for Users in India

Contacts for information, support, and services are:

### World Wide Web

<http://www.epson.co.in>

Information on product specifications, drivers for download, and products enquiry are available.

### Helpline

- Service, product information, and ordering consumables (BSNL Lines)
  - Toll-free number: 18004250011
  - Accessible 9am to 6pm, Monday through Saturday (Except public holidays)
- Service (CDMA & Mobile Users)
  - Toll-free number: 186030001600
  - Accessible 9am to 6pm, Monday through Saturday (Except public holidays)

## Where to Get Help

### Help for Users in the Philippines

To obtain technical support as well as other after sales services, users are welcome to contact the Epson Philippines Corporation at the telephone, fax numbers and e-mail address below:

#### World Wide Web

<http://www.epson.com.ph>

Information on product specifications, drivers for download, Frequently Asked Questions (FAQ), and E-mail Enquiries are available.

#### Epson Philippines Customer Care

Toll Free: (PLDT) 1-800-1069-37766

Toll Free: (Digital) 1-800-3-0037766

Metro Manila: (+632)441-9030

Web Site: <https://www.epson.com.ph/contact>

E-mail: [customercare@epc.epson.com.ph](mailto:customercare@epc.epson.com.ph)

Accessible 9am to 6pm, Monday through Saturday (Except public holidays)

Our Customer Care team can help you with the following over the phone:

- Sales enquiries and product information
- Product usage questions or problems
- Enquiries on repair service and warranty

#### Epson Philippines Corporation

Trunk Line: +632-706-2609

Fax: +632-706-2663